



**LED** aquaristik



**LED** terraristik  
Eine Marke der LEDaquaristik GmbH

Instructions for installation

Operating instructions

Product information

Technical data

2024<sup>2</sup> 

Download <http://katalog.ledaquaristik.de>

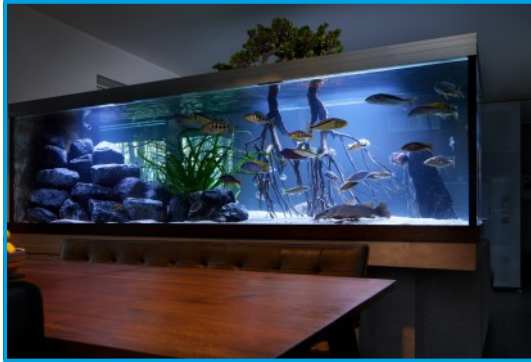

The LEDaquaristik GmbH offers powerful and natural LED lighting in an incomparably large variety of versions. This brilliantly sets the scene for your aquarium or terrarium and opens up an exceptionally lively and colourful underwater, plant and animal world. Of course, all our LED bars are waterproof, as well as dimmable and suitable for light control/daylight simulation.

Due to decades of experience in aquaristics, LEDaquaristik offers you above-average product competence and know-how. We produce our lighting systems according to the

latest LED technology, whereby reliability and service life are always the focus. High-quality materials and components precisely matched to each other, as well as careful processing, form the foundation for a high standard of quality.

Our company is characterised by in-house development and production, resulting in innovative and unique products. These include energy-efficient LED modules with water cooling and heat recovery, or exclusive lighting controls with an impressive range of functions and operating concept (SunRiser 8). Elegant lamp housings, flexible mounting solutions and the innovative aquarium cover made by custom size round off the product range.

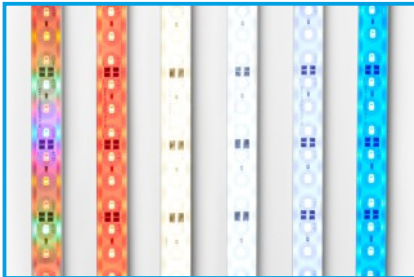

Based on the principle of a modular system, you can assemble your LED lighting flexibly and individually according to your personal requirements and wishes. Whether a simple starter set for 1:1 replacement of old fluorescent tubes or a sophisticated complete system with daylight simulation. There is an almost infinite number of possible combinations, and the lighting can be expanded at any time.

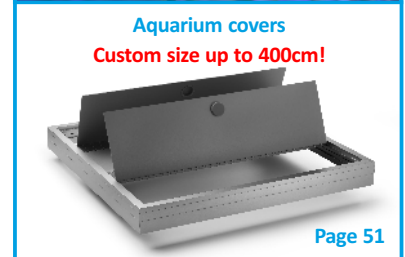
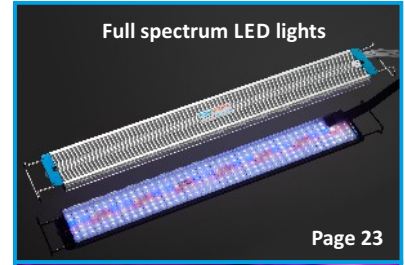

# Table of contents

## What LEDaquaristik stands for

### Important notes on use

### Commissioning and operation

### Care and maintenance

### Warranty and return



## LED module and compact systems

eco+ module system	7
PRO <sup>2</sup> module system	11
Available light colours	15
Plant light GROWx5 and PLANT-GROW LEDs	17
UVA / SKY-GROW = Full spectrum 2.0	18
spotBEAM controllable LED spots for daylight simulation	19
aquaLUMix compact luminaire	23
aquaLUMix reflector - aperture - mirror unit	31
Heat recovery	33

## Accessories

• Water cooling connection	34
• Seawater - TITAN Upgrade	35
• Cleaning the water cooling system	35
• CO2 pressure reducer and diffuser	36
• Accessories overview	37
• Connector for cable extension	38
• Power supply: High Performance LED Switching Power Supplies	39
• Mains filter and overvoltage protection	40
• Manual 1 Channel Dimmer	41
• DIMIX6 - Manual 6 Channel LED Dimmer & Mixer	42

## Mounting and fixing solutions

• CleanCover	43
• Silicone feet	44
• Bracket holder for PRO <sup>2</sup> LED bars <b>NEW</b>	44
• T5/T8 brackets	45
• TRIO holder	47

• AddON adapter plate	47
• U-profile as longitudinal or cross support	49
• E-profile as guide rail for covers	50
• Aquarium covers	51
• Service: Customised cover divisions	57
• Aquarium covers <b>with customized length NEW</b>	61
• Gravel panels with customized length <b>NEW</b>	62
• Lamp housings for LED strips	63
• Retaining bridges Installation and fitting	66
• LED adapter profiles for JUWEL, EHEIM & Co.	69
• Covers for JUWEL & EHEIM incl. cover flaps	72

## Light control / day simulation

• SimuLUX	74
• SunRiser 2XL <b>NEW</b>	75
• SunRiser 6 <b>NEW</b>	77
• Decision-making aid: A comparison of our lighting controls	82
• SunRiser 8	83
• Temperature sensor for SunRiser 8	89
• Y-cable for double assignment	90
• Wall bracket for light controls	90
• WLAN extension for SunRiser 8	91
• High-Power Solution for SunRiser	93

## LED spots and pendant luminaires

• powerBEAM: dimmable high-performance pendant luminaire	95
• easyBEAM: E27 18W CREE LED spotlight	99
• flexBEAM: HQL replacement & pendant luminaire	101

## Services

Pre-assembly, programming & sample case for loan	107
FAQ - Frequently asked questions	30, 52, 92
References	106
Price list	109
Customer opinions	110
Customer photos	111

## Important notes on use

We are pleased that you have decided to purchase our products and thank you for the confidence you have placed in us. Our products are always manufactured with the utmost care and using the latest technology.

Please read all chapters of these instructions for use carefully first and check your order for completeness. Please observe the safety instructions as well as the recommendations for maintenance and care.

We have taken the greatest care in the development of these operating instructions. However, we cannot accept any liability for possible printing errors and mistakes. Technical specifications are approximate. We reserve the right to make technical changes.

### Intended use

Our products and all parts included in the scope of delivery are intended exclusively for the illumination of aquariums, terrariums and plant cultivation in compliance with the technical data.

### Safety instructions



The purchased devices may pose a risk to persons and property if they are used improperly or not in accordance with their intended use or if the safety instructions are not followed. Remove the packaging before putting the unit into operation!

- The devices can be used by children aged 8 years and above and persons with reduced physical, sensory or mental capabilities or lack of experience and knowledge if they have been given supervision or instruction concerning use of the device in a safe way and understand the hazards involved. Children must not play with the device and must be supervised during cleaning and user maintenance.
- Before use, visually inspect the device to ensure that it is undamaged, especially the power cord and plug.
- Check that the LED bar is firmly seated before use.
- The electrical devices may only be operated indoors.



- Power supply unit, dimmer, controls or distributor must not be placed on or inside the aquarium cover!
- Always disconnect the mains plug before working on the LED bar!
- Operation only with the FI circuit breaker, max. 30 mA.
- The mains plugs of the electrical devices must not get wet. Connect the mains plugs to the mains at a height so that there is a loop in the connecting cable where water could drip off.

- The minimum distance of the LED bar to the water surface should be 50mm or the LED bar must not get wet permanently or repeatedly.
- The light sources manufactured according to protection class IP67 can also be used inside an aquarium cover. Explicitly not suitable for underwater use! LED spotlights manufactured to protection class IP44 must not be used inside a damp environment or even inside the aquarium cover.
- LED bars of protection class IP67 cannot be opened and must be completely replaced if defective.
- Avoid looking directly into the switched-on LEDs for a longer period of time, otherwise you risk eye injuries! This applies in particular to UV LEDs.

Our products comply with the directives of the European Community (EU) and are therefore CE-compliant.

### Suspended mounting

When installing hanging lights, choose a fastening that matches the existing ceiling and construction. Our cable systems come with standard dowels and screws, these may not be suitable for your situation on site.

### The right power supply



Only LED power supplies with a 12V DC output voltage may be used. Unsuitable power supply units lead very quickly and inevitably to a defect of the LEDs - any warranty claims are void!

To determine the power your power supply unit must have, proceed as follows. Add the power values (watts) of the LED bars to be connected plus a 10% reserve. The next larger power supply unit is then the right choice. You can find our power supply calculator at: [www.ledaquaristik.de/power-supply](http://www.ledaquaristik.de/power-supply)

**Please also note the information on overvoltage protection on page 40.**

### Commissioning and operation

#### Connecting the LED light with the accessories

Connect the LED luminaire to the power supply adapter or distributor, dimmer or day simulation. See graphic on the right for connection sequence. Recommended tool: phase tester / screwdriver.



**Always observe the maximum load capacity and power of the individual products depending on the power supply unit used and the number of LED bars. Performance data can be found in the product descriptions / technical data. Always avoid overloading and incorrect polarity!**

## Colour coding of the connection cables

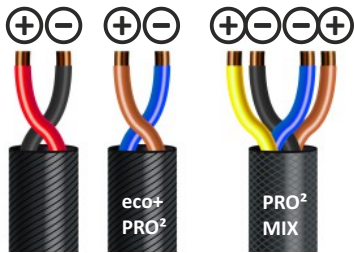

## Maintenance and care

The following sections describe maintenance work that is required for optimal and trouble-free operation. Regular maintenance extends the service life and ensures the function of the products over a long period of time.

- During maintenance and servicing, always disconnect the lighting from the mains.
- If necessary, we recommend cleaning with a soft cloth and mild detergent.
- Permanent moisture as well as limescale and dirt deposits can negatively affect the light quality, performance and service life of the LED bars.
- For closed covers, we recommend using the CleanCover.
- For light sources that cool passively via the ambient air, choose a well-ventilated location. Complete enclosure leads to a build-up of heat and impairs the service life. With closed aquarium covers, the existing openings for cables and hoses are usually sufficient for ventilation; observe the heat development and create additional openings if necessary.
- Compared to fresh water, seawater is an extremely aggressive medium and only very few materials can withstand direct and permanent contact. To avoid unnecessarily shortening the life of the LED bars, appropriate precautions should be taken when using them in seawater. A glass cover on the aquarium is probably the best protection for the lighting. The water cooling system can only be used in saltwater areas with the TITAN extension!

**In addition, please note and follow the instructions for the individual products on the following pages of these operating instructions!**

## Troubleshooting

### 1. The LED bar does not light up or flickers.

Possible causes: The LED power supply unit does not supply voltage, is defective or the mains plug is not plugged in.

A failure of a complete LED bar is very unlikely. Mostly, such a failure is due to a defective connection or cable extension.

Therefore, please check the connection to the power supply/control unit to ensure that the terminals are correctly and firmly connected.

An improper cable extension/connection can lead to reduced performance, flickering or failure (loose contact).

### 2. In case of SunRiser 8 malfunctions, see chapter SunRiser 8/ Troubleshooting. 3.

### 3. in case of other malfunctions, please contact LEDaquaristik Support.

## Connection sequence

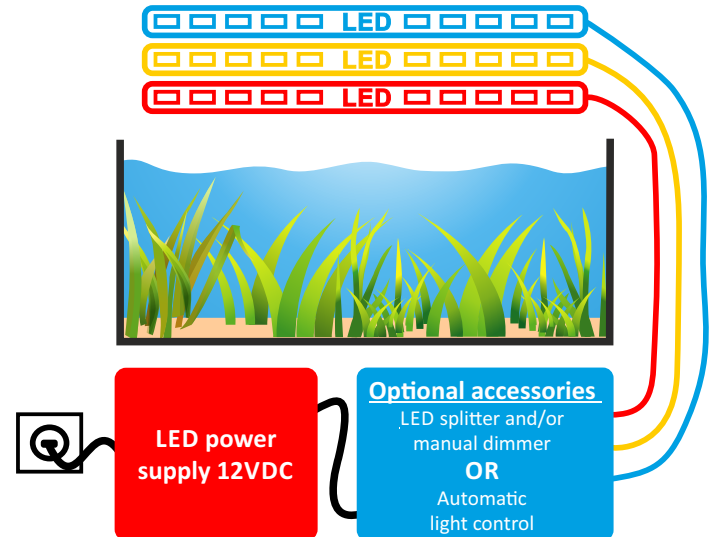

## Warranty declaration

Fith regard to our LEDaquaristik products, we provide the purchaser with a guarantee for a period of 24 months, provided that the purchaser is a consumer, in the event that our product should be defective, in accordance with the following provisions:

### § 1 Scope of warranty

(1) The warranty covers the LEDaquaristik product purchased by you together with all the individual parts belonging to it, with the exception of consumable parts such as hoses, soldering connectors, extension cables and filter media. It is limited to the product itself and does not extend to damage to other property and/or persons. In addition, the provisions of the Product Liability Act shall apply, which are not limited by the above provision.

(2) The warranty is provided in the form that, at our discretion, the complete product or individual parts thereof will be replaced or repaired. In the event of failure, the purchase price shall be reduced or the product shall be taken back against reimbursement of the purchase price, at your discretion.

### § 2 Warranty period and procedure

(1) The warranty begins on the day of delivery of the LEDaquaristik product to the customer. A prerequisite for the granting of the guarantee is that our product has been used for its intended purpose and has not been improperly handled or maintained, in particular that the relevant instructions for use have been observed, and furthermore that the product or its individual parts have not been repaired by workshops or persons not authorised to do so. Furthermore, the guarantee does not apply if the product shows mechanical damage of any kind, in particular glass breakage.

(2) If defects become apparent within the warranty period, the warranty claims must be asserted immediately, but at the latest within a period of fourteen days from the occurrence of the defect, with the specialist dealer who supplied the product. The statutory warranty rights shall remain unaffected.

(3) Warranty claims will only be considered if the invoice for the LEDaquaristik product is presented.

Subject to technical changes

## Order withdrawal and return

Consumers have the following right of withdrawal:

**You have the right to withdraw from this contract within fourteen days without giving any reason. The revocation period is fourteen days from the day on which you or a third party named by you, who is not the carrier, has or has taken possession of the goods.**

In order to exercise your right of withdrawal, you must inform us (LEDaquaristik GmbH, Schierbusch 2, 33161 Hövelhof) of your decision to withdraw from this contract by means of a clear declaration. Please use the cancellation form at [www.ledaquaristik.de/Withdrawal-form](http://www.ledaquaristik.de/Withdrawal-form), which is, however, not mandatory. If you make use of this option, we will send you confirmation of receipt of such revocation without delay (e.g. by e-mail). To comply with the revocation period, it is sufficient that you send the notification of the exercise of the right of revocation before the expiry of the revocation period.

If you withdraw from this contract, we must refund all payments we have received from you, including delivery costs (with the exception of additional costs resulting from the fact that you have chosen a type of delivery other than the cheapest standard delivery offered by us), without delay and at the latest within fourteen days from the day on which we received the notification of your withdrawal from this contract. For this repayment, we will use the same means of payment that you used for the original transaction, unless expressly agreed otherwise with you; in no case will you be charged for this repayment. We may refuse repayment until we have received the goods back or until you have provided proof that you have returned the goods, whichever is the earlier.

You must return or hand over the goods to us without delay and in any case no later than fourteen days from the day on which you notify us of the cancellation of this contract. The deadline is met if you send the goods before the expiry of the period of fourteen days. You shall bear the direct costs of returning the goods.

**You only have to pay for any loss in value of the goods if this loss in value is due to handling of the goods that is not necessary for testing the quality, properties and functionality of the goods and that goes beyond the testing of the properties and functionality. Testing the properties and functionality" is understood to mean testing and trying out the respective goods, such as is possible and customary in a shop.**

**The right of withdrawal does not apply to contracts for the delivery of goods that are not prefabricated and for the manufacture of which an individual selection or determination by the consumer is decisive or which are clearly tailored to the personal needs of the consumer.**

### Return costs

Insofar as you make use of an existing right of revocation, you must bear the regular costs of the return shipment. This also applies if you have not yet paid the consideration or a contractually agreed partial payment at the time of the revocation.

# Electrical and electronic equipment

- Please dispose of old appliances properly -



## Information for private households

The Electrical and Electronic Equipment Act (ElektroG) contains a large number of requirements for the handling of electrical and electronic equipment. The most important ones are summarised here.

### 1. separate collection of old appliances

Electrical and electronic equipment that has become waste is referred to as WEEE. Owners of WEEE must dispose of it separately from unsorted municipal waste. In particular, WEEE does not belong in household waste, but in special collection and return systems.

### 2 Batteries, rechargeable batteries and lamps

Owners of WEEE must, as a rule, separate spent batteries and accumulators that are not enclosed in the WEEE, as well as lamps that can be removed from the WEEE without causing damage, from the WEEE before handing them in at a collection point. This does not apply if WEEE is prepared for re-use with the involvement of a public waste management authority.

### 3 Options for the return of WEEE

Owners of WEEE from private households can return it free of charge to the collection points of the public waste management authorities or to the take-back points set up by manufacturers or distributors as defined by the ElektroG.

Shops with a sales area of at least 400 m<sup>2</sup> for electrical and electronic equipment as well as those grocery shops with a total sales area of at least 800 m<sup>2</sup> which offer electrical and electronic equipment several times a year or on a permanent basis and make it available on the market are obliged to take it back. This also applies to distribution using means of distance communication if the storage and dispatch areas for EEE are at least 400 m<sup>2</sup> or the total storage and dispatch areas are at least 800 m<sup>2</sup>. Distributors shall, in principle, ensure take-back by providing suitable return facilities within reasonable distance from the respective end-user.

The possibility of returning an old device free of charge exists for distributors who are obliged to take it back, among other things, if a new device of the same kind, which essentially fulfils the same functions, is supplied to an end user. If a new device is delivered to a private household, the similar WEEE may also be handed over there for collection free of charge; this applies in the case of distribution by means of distance

communication for devices of categories 1, 2 or 4 according to Article 2(1) ElektroG, namely "heat transmitters", "display screen equipment" or "large appliances" (the latter with at least one external dimension exceeding 50 centimetres). End-users are asked about their intention to return electrical and electronic equipment when they conclude a purchase contract. In addition, there is the possibility of free return to the collection points of the distributors, irrespective of the purchase of a new appliance.

In addition, there is the possibility of free return at the collection points of the distributors, irrespective of the purchase of a new device, for such old devices which are not larger than 25 centimetres in any external dimension, and this is limited to three old devices per type of device.

### 4. data protection notice

Old appliances often contain sensitive personal data. This applies in particular to information and telecommunications technology devices such as computers and smartphones. In your own interest, please note that each end user is responsible for deleting the data on the end-of-life devices to be disposed of.

### 5. Meaning of the symbol "crossed-out dustbin"



The symbol of a crossed-out wheeled bin regularly displayed on electrical and electronic equipment indicates that the respective device must be collected separately from unsorted municipal waste at the end of its service life.

Producer information according to § 18 para. 4 ElektroG (new)

# LED module system: eco+

Great performance, low price!

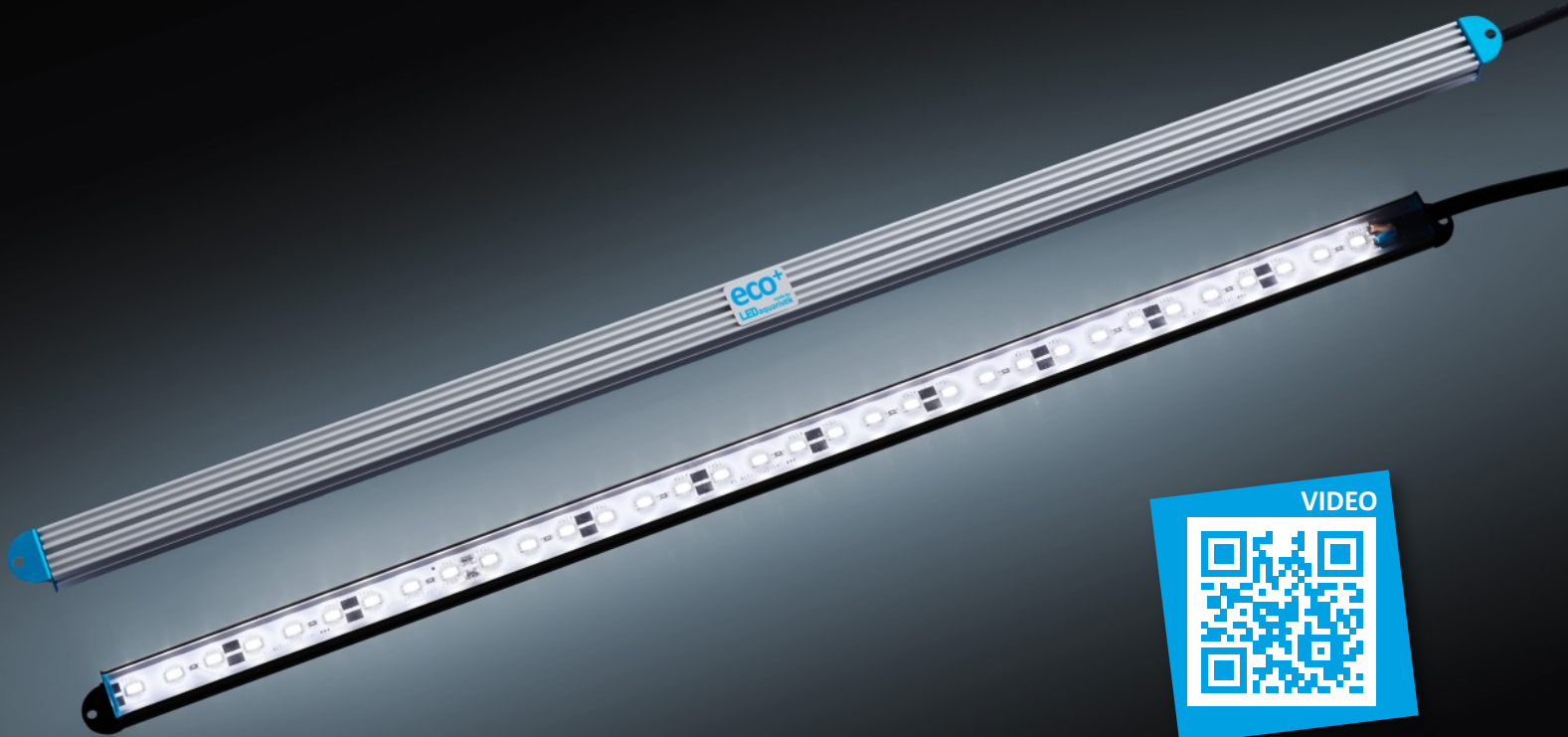



## eco+ LED Bars - Energy-Efficient and Versatile Aquarium LED Lighting

Explore the world of energy-efficient eco+ LED bars for aquariums. With lengths ranging from 20 to 140 cm and a selection of 12 different light colors, we offer countless combination possibilities to customize your aquarium lighting exactly to your preferences. Whether you have a 30 cm or 300 cm aquarium, our LED bars brilliantly showcase your aquarium, creating a vivid and colorful underwater world.

Our modular building system allows you to tailor the LED lighting to your individual needs, from minimal to maximum light requirements. You can also easily expand the system later, whether through additional LED bars, moonlight, or a light control system. Just remember to plan for a powerful power supply for future expansions.

### Versatile Lighting Solutions for Your Underwater World

With eco+ LED bars, we provide the ideal solution for various freshwater and saltwater aquariums. Our LED bars allow you to choose from a wide range of daylight colors (3500K to 13000K) as well as effect colors like red and blue. You can even achieve a realistic day simulation through our exclusive SunRiser devices.

The eco+ LED bar features ultra-bright high-power LEDs and an exceptionally high color rendering index (CRI) of up to 90 Ra. This ensures impressive colors and a vibrant atmosphere in your aquarium. Thanks to the nearly 160° beam angle (Clearsealing) and strong performance, our LED bars offer even lighting and full coverage – even for large aquariums.

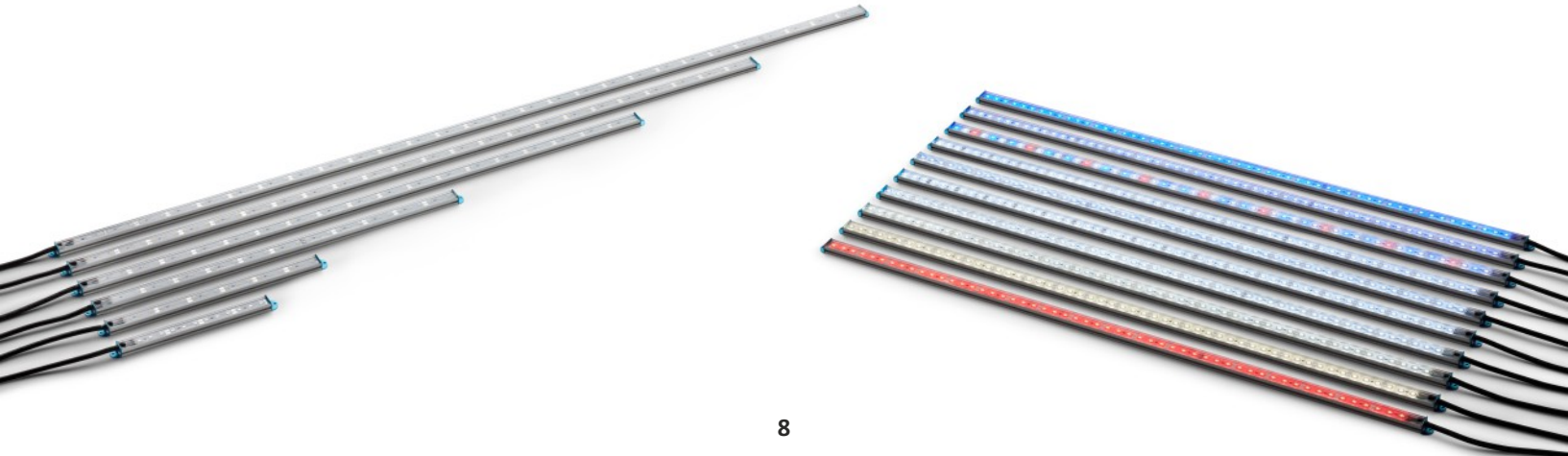

### Eco+ LED Bars: Perfect Lighting for Aquariums and Terrariums.

Our LED bars of the eco+ type are specifically designed for illuminating aquariums and terrariums. With LED bars, you enjoy targeted light that is unlike fluorescent tubes, which scatter light. Reflectors become unnecessary, and you can position the bars individually above your aquarium – front, rear, center, or diagonal. Experience fascinating depth and unparalleled visual design possibilities.

Choose the perfect length, with 7 different options between 20 and 140cm. Whether used individually or in multiple combinations, with the same or different light colors, the applications are versatile. The recommended combination depends on the lighting needs of the habitat: size, layout, planting, and stocking. More information can be found in our FAQ, and our light comparison shows possible combination options with other light colors in a photo comparison. Learn more about our high-quality LED bars and create a lively, natural ambiance for your underwater world.

Our LEDs are directly and inseparably connected to the heat sink, ensuring optimal heat dissipation. This efficient cooling eliminates the need for noisy fans that would consume electricity. Thanks to the slim dimensions, the eco+ LED bars fit even in tight spaces – only 18 mm wide and 12 mm high, with lengths ranging from 20 to 140 cm.

Expand your aquarium with the unique lighting of eco+ LED bars and immerse yourself in a breathtaking underwater world full of vibrant colors and liveliness.

**Tip:** Utilizing a dimmer allows gentle regulation of luminosity without visible loss of brightness. This cuts energy use and enhances lifespan, effects also achievable with automatic light control or daily simulation.

### Features:

- High-Power LEDs: Up to 33% brighter than standard models.
- Unique ripple effect and play of light, creating a natural ambiance.
- Dimmable: Manually or automatically.
- Sleek Design: 18x12mm, available from 20-140cm.
- 7 different lengths for maximum design flexibility.
- High-quality passive heatsink made from solid aluminum.

### Mounting Options:

- Integration into our aquarium cover.
- Special brackets for T5 or T8 damp-proof fixtures.
- Simple setup with silicone stands.
- Modern aluminum lamp housing for various applications, including as a frame-mounted lamp, suspended lamp, or even within the cover.
- LED adapter profiles for modernizing JUWEL and EHEIM aquariums.
- U-profiles for flexible LED bars mounting.
- Included standard mounting screws if no other bracket is chosen.
- Additional accessories for individual mountings in spare parts section.



## eco+ LED bar

### Technical data

The following data refer to the variant "eco+ LED bar DAY 5500K" as an example, other variants and light colours differ!

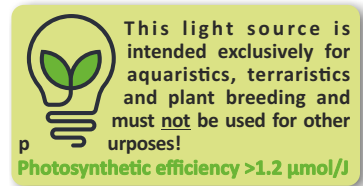

Variant	LxWxH (mm)	LEDs	System output	Lumen	Effizienz	Energy consumption	Ra/CRI	PAR/PPFD at 30 cm
140cm	1400x18x12	84 pcs	35 W	3.252 lm	93 lm/W	35 kWh/1000h	89,5	55 [μmol/m <sup>2</sup> s]
116cm	1156x18x12	81 pcs	37 W	3.799 lm	103 lm/W	37 kWh/1000h	88,7	71 [μmol/m <sup>2</sup> s]
100cm	995x18x12	69 pcs	33 W	3.499 lm	107 lm/W	33 kWh/1000h	88,7	70 [μmol/m <sup>2</sup> s]
80cm	790x18x12	54 pcs	28 W	2.995 lm	107 lm/W	28 kWh/1000h	88,8	68 [μmol/m <sup>2</sup> s]
50cm	500x18x12	33 pcs	19 W	2.076 lm	110 lm/W	19 kWh/1000h	89,9	60 [μmol/m <sup>2</sup> s]
30cm	295x18x12	18 pcs	11 W	1.184 lm	108 lm/W	11 kWh/1000h	89,0	38 [μmol/m <sup>2</sup> s]
20cm	210x18x12	12 pcs	8 W	827 lm	104 lm/W	8 kWh/1000h	89,1	27 [μmol/m <sup>2</sup> s]

Further data and diagrams on the light spectrum are available in the product description under ("Data sheet & key figures") of the respective LED bar.

*\*The light measurement of the product was carried out according to the scope of delivery in a dry environment at 100% output. The use of dimmers, light controls, other power supplies, focusing lenses, protective covers or reflectors may lead to deviating results. In addition, slight deviations from the test sample may occur due to the batch. PPFD - Photosynthetic Photon Flux Density. PAR - Photosynthetically active radiation. PPE - Photosynthetic photon flux per watt of electrical energy.*

Beam angle	120°, effective 160° due to ClearSealing
Voltage	12V DC (direct current)
LED chip service life	~50.000 h
Switching cycles	until premature failure: approx. 100,000
Light source	LEDs not replaceable due to design.
Switching time	none
Ingress protection class	IP67 – not suitable for underwater use!
Dimmable	yes
Cooling	Passive via solid aluminium heat sink

# LED module system: PRO<sup>2</sup>

Next Generation of Lighting with Heat Recovery

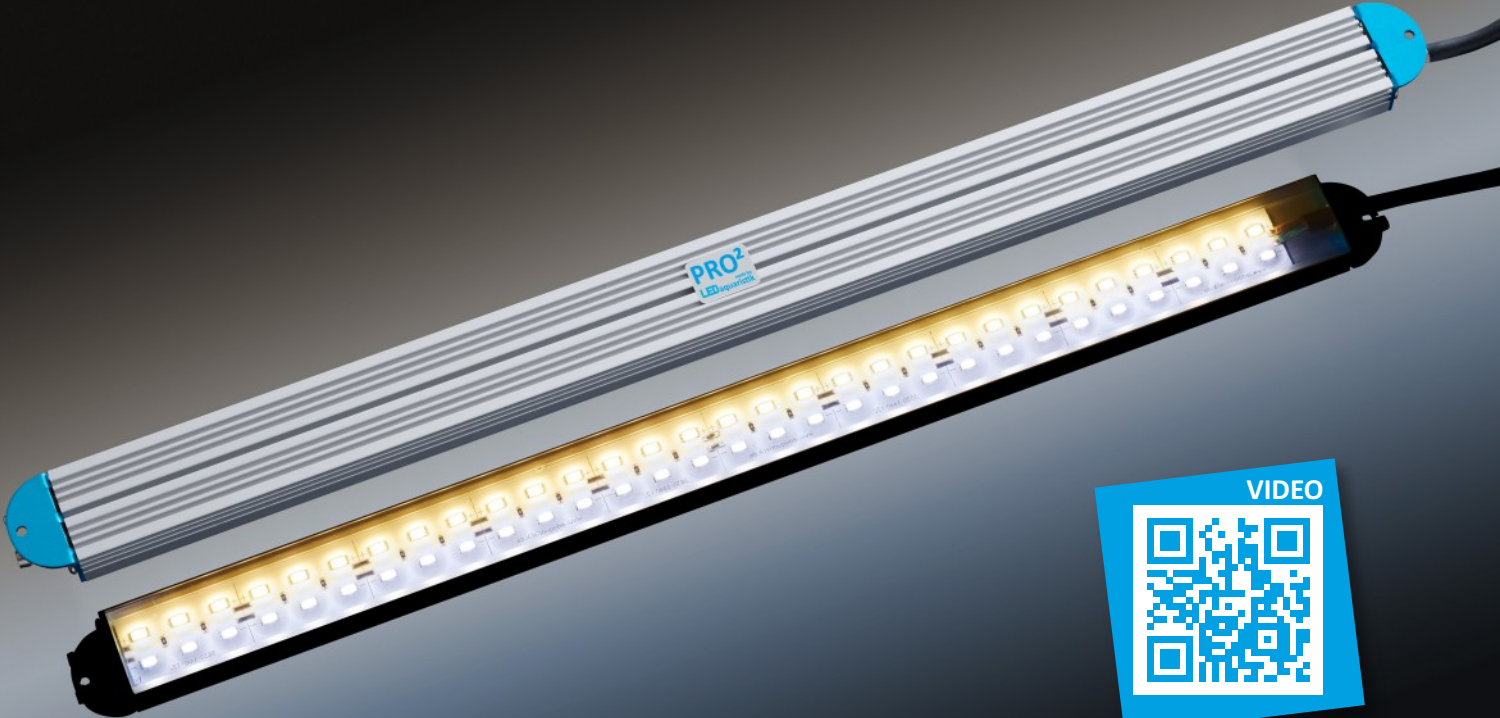

**PRO<sup>2</sup> LED Bars for Aquariums & Terrariums: Experience the cutting-edge LED technology with our PRO<sup>2</sup> LED bars. Unlike the eco+ version, this model is designed with a dual-row LED configuration, ensuring superior luminosity per unit.**

Step into the future of aquarium lighting with our energy-efficient PRO<sup>2</sup> LED bars. Available in lengths ranging from 47 to 135 cm and offering 11 different light colors, our LED bars provide you with countless combinations. Whether your tank is 60 cm or 300 cm in length, our LED bars will beautifully illuminate your aquarium, creating a vibrant and colorful underwater world. Additionally, our innovative heat recovery system effectively supports your aquarium's heating needs.

**Versatile Applications:** Depending on your specific lighting needs, you can combine multiple PRO<sup>2</sup> LED bars of the same or different light colors. We recommend mixing with another light color for visually stunning simulations. The ideal selection and combination depend on various factors such as habitat size, setup, and planting. Get inspired by our light comparison that showcases different combination possibilities through photo comparisons.

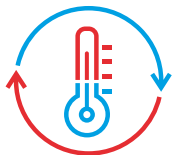

#### **Features:**

- **Powerful and Brilliant:** High-Power LEDs emit up to 33% more brightness than standard ones, creating a natural shimmer effect on the aquarium floor.
- **Flexible Dimming:** Manual or automatic brightness control for captivating day simulations.
- **Sleek and Versatile:** Compact profile of 32x18mm; available in 6 lengths ranging from 47-135 cm and 11 color variations.
- **Convincing Quality:** Solid aluminum single-piece passive heat sink for optimal heat dissipation and durability.

**HIGHLIGHT – The Heat Recovery System:** Each PRO<sup>2</sup> LED bar offers the option of water cooling. You can decide whether you want to utilize this unique water cooling technology or not. The temperature-optimized aluminum profile ensures effective passive cooling. However, with active water cooling, you achieve optimal LED cooling, efficiently utilize the generated heat, and additionally warm your aquarium – a dual function that is unparalleled in this industry. Details and a helpful calculator can be found under [Save Energy](#).

**Tip:** Using a dimmer allows gentle regulation of brightness without visible loss in luminosity. This reduces energy consumption and increases the lifespan – effects that can also be achieved through automatic light control or day simulation.

**Mounting options according to eco+ LED bars**



# PRO<sup>2</sup> LED bar

## Technical data

The following data refer to the variant "PRO<sup>2</sup> LED bar SUNSET 3500K" as an example, other variants and light colours differ!



Connections for water cooling and heat recovery



This light source is intended exclusively for aquaristics, terraristics and plant breeding and must not be used for other purposes!  
 Photosynthetic efficiency >1.2 μmol/J

Variant	LxWxH (mm)	LEDs	System output	Lumen	Effizienz	Energy consumption	Ra/CRI	PAR/PPFD at 30 cm
135cm	1354x32x18	156 pcs	55 W	6.804 lm	98 lm/W	55 kWh/1000h	84,4	98 [μmol/m <sup>2</sup> s]
106cm	1062x32x18	126 pcs	47 W	5.690 lm	100 lm/W	47 kWh/1000h	84,3	100 [μmol/m <sup>2</sup> s]
96cm	962x32x18	132 pcs	53 W	6.503 lm	121 lm/W	53 kWh/1000h	85,8	121 [μmol/m <sup>2</sup> s]
75cm	755x32x18	102 pcs	42 W	5.460 lm	117 lm/W	42 kWh/1000h	84,4	117 [μmol/m <sup>2</sup> s]
67cm	674x32x18	90 pcs	38 W	5.036 lm	113 lm/W	38 kWh/1000h	84,3	113 [μmol/m <sup>2</sup> s]
47cm	467x32x18	60 pcs	28 W	3.764 lm	101 lm/W	28 kWh/1000h	84,2	101 [μmol/m <sup>2</sup> s]

Further data and diagrams on the light spectrum are available in the product description under ("Data sheet & key figures") of the respective LED bar.

*\*The light measurement of the product was carried out according to the scope of delivery in a dry environment at 100% output. The use of dimmers, light controls, other power supplies, focusing lenses, protective covers or reflectors may lead to deviating results. In addition, slight deviations from the test sample may occur due to the batch. PPFD - Photosynthetic Photon Flux Density. PAR - Photosynthetically active radiation. PPE - Photosynthetic photon flux per watt of electrical energy.*

Beam angel	120°, effective 160° due to ClearSealing
Voltage	12V DC (direct current)
LED chip service life	~50.000 h
Switching cycles	until premature failure: approx. 100,000
Light source	LEDs not replaceable due to design.
Switching time	none
Ingress protection class	IP67 – not suitable for underwater use!
Dimmable	yes
Cooling	Passive via solid aluminium heat sink Alternatively by water cooling

## Available colour combinations of the PRO<sup>2</sup> LED bars

The LED bars of the PRO<sup>2</sup> MIX type are equipped with two different light colours in parallel, which can of course be switched and controlled independently of each other. This means that even with just one LED bar, there are many possibilities for daylight simulation and individual colour mixing. With minimal space requirements, these LED bars provide maximum output, a wide colour spectrum and the option of heat recovery. For more information on the colour spectrum, see [page 15](#).

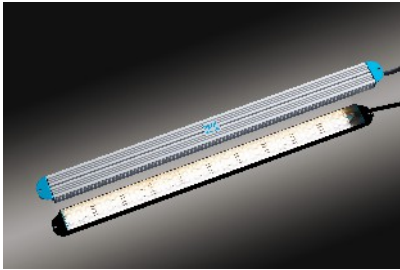

### SUNSET + DAY

Community aquariums and day simulation, warm light

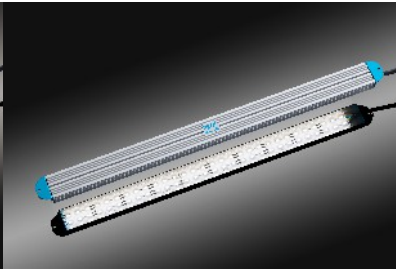

### TROPIC + SKY

Community aquariums, Tendency towards white light

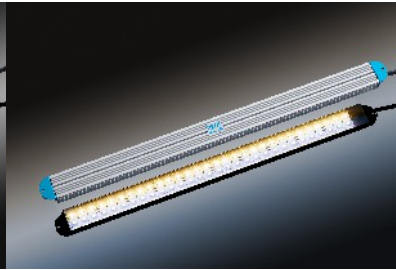

### SUNSET + POLAR

Good day simulation e.g. for discus or Malawi and Tanganyika

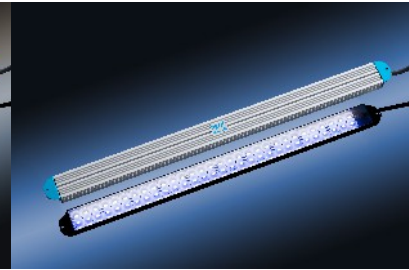

### POLAR + MARINE

Very blue-heavy e.g. for East Africa like Malawi and Tanganyika

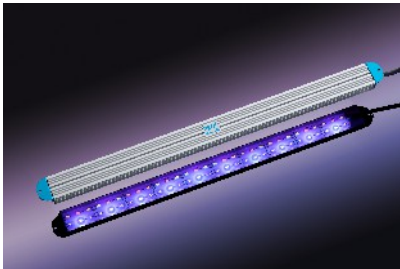

### UVA + SKY-GROW

Special lighting, see [page 18](#)

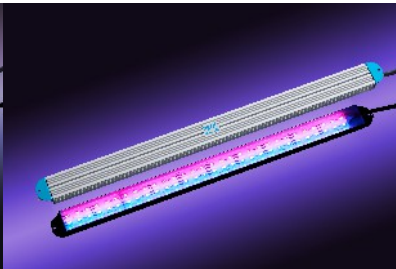

### RED + ROYAL BLUE

Effect light colours for day simulation, sunrise / moon

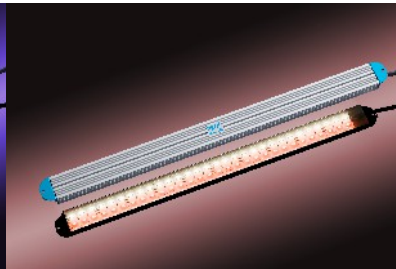

### PLANT-GROW + TROPIC

Plant light with TROPIC, if necessary with to be supplemented with further LEDs

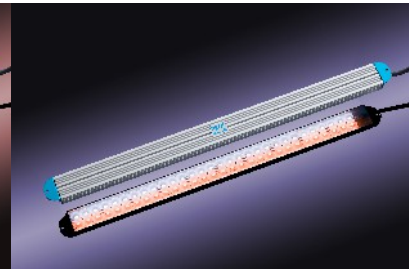

### PLANT-GROW + POLAR

Plant light with POLAR, if necessary with to be supplemented with further LEDs

## Available light colours: *Further comparison photos and data at: [www.ledaquaristik.de/Lichtvergleich](http://www.ledaquaristik.de/Lichtvergleich)*

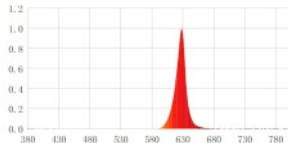

### RED

Light colour 625nm

A red light with 625nm. It can be used as a supplement to the main lighting to promote plant growth, but is also very suitable for day simulation as light for sunrise and sunset.

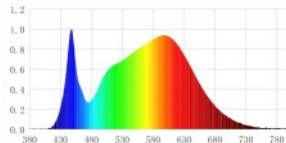

### SUNSET

Light colour 3500K  
Ra/CRI = 86,1

A warm light with a high red component, advantageous for planted aquariums, possibly in combination with another light colour. Also very suitable when using a day simulation as light for sunrise and sunset.

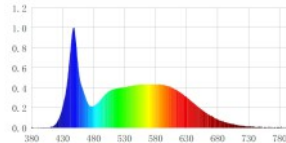

### TROPIC

Light colour 4500K  
Ra/CRI = 88,7

A warm, tropical light, advantageous for planted aquariums. In addition, the TROPIC offers high brightness with good colour rendering.

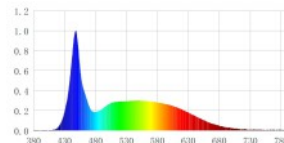

### DAY

Light colour 5500K  
Ra/CRI = 89,1

A pleasant pure white light, very close to nature, like on a sunny day with a cloudless sky. Very well suited for general main lighting.

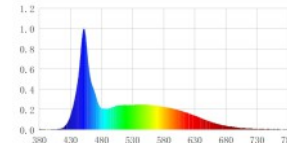

### SKY

Light colour 6500K  
Ra/CRI = 87,6

A very bright, neutral white light with a slight blue tint. Highest colour rendering and good combination possibilities with other light colours.

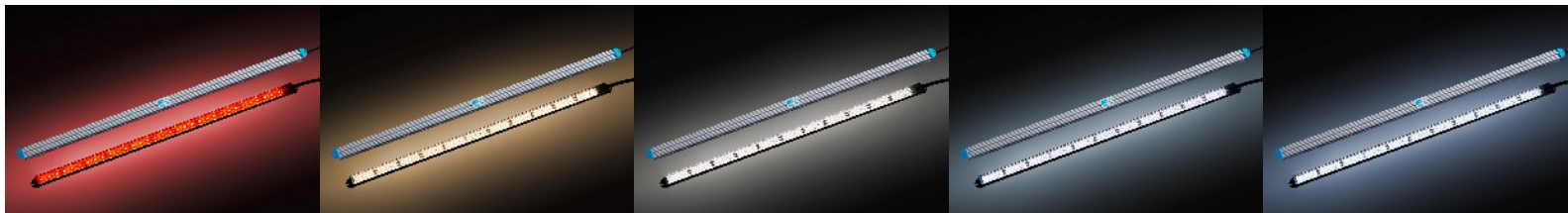



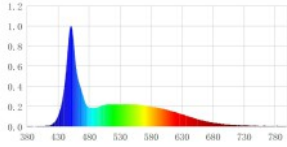

## POLAR

Light colour 7500K  
Ra/CRI = 85,8

A cool white-blue light, yet very natural. Mostly the first choice for the main lighting of East African aquariums (Malawi/Tanganyika).

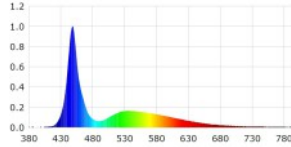

## REEF

Light colour 11000K

A light with an increased blue component, which is also in freshwater (increased depth effect).

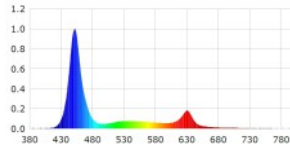

## CORAL

Light colour MIX

CORAL is a mix of different colours, interesting for general colour support or for marine aquaristics: 50% white 11,000K, 33% blue 460nm and 17% red 625nm.

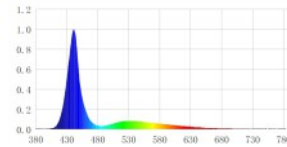

## MARINE

Light colour 13000K

An ice-cold light with a high blue component. Often used for Tanganyika, Frontosa or seawater.

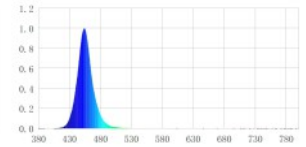

## ROYAL BLUE

Light colour 460nm

A blue light at a wavelength of 460nm, usable e.g. as moonlight or in marine applications.

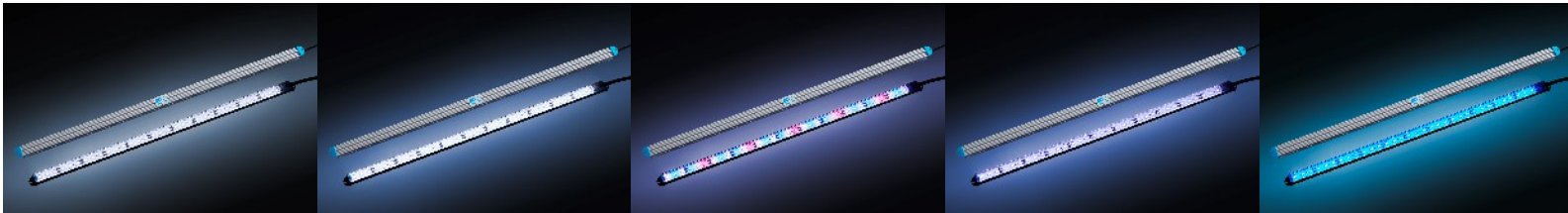

# Plant light GROWx5 and PLANT-GROW

These light colours are an innovation in LED aquaristics and are used in our eco+, PRO<sup>2</sup> and aquaLUMix products.

GROWx5 is a unique light composition of 5 different wavelengths that promote optimal photosynthesis and healthy plant growth. Essentially, a balanced proportion of blue and red light spectrum is responsible for this, supplemented by three other specially matched colour spectra: green, orange and ultra-red.

In contrast to the GROWx5, the PLANT-GROW combines these light spectra in just one chip. Thus, the PLANT-GROW is more discreet (less colourful), but also somewhat less specialised, but produces a brighter and more even light compared to the GROWx5.

Both versions are designed more as optional light in combination with other "white" light colours, as these light colours appear slightly purple/violet on their own. Thus, this special LED plant light is comparable to the well-known and universally popular GROLUX fluorescent tube. The overall colourfulness of the aquarium is enhanced.

## The colour spectra in detail:

**Red and ultra-red** - For optimal photosynthesis, both red and ultra-red must be available to the plant. A high red and a comparatively low blue content ensure magnificent plant growth.

**Blue** light is ideal for the growth phase and ensures lush green with strong, compact growth. Exclusively blue light, on the other hand, causes the plant to become stunted. The more light components from the blue-violet and blue spectrum, the larger the leaves will grow.

**Green** - A widespread assumption is that green and **orange** are absorbed by the plant only slightly or not at all. The green light would be reflected by the leaves and give them their green colour. However, recent studies show that plants absorb the majority of wavelengths in the green range through carotenoids and other auxiliary pigments, thus significantly enhancing photosynthesis.

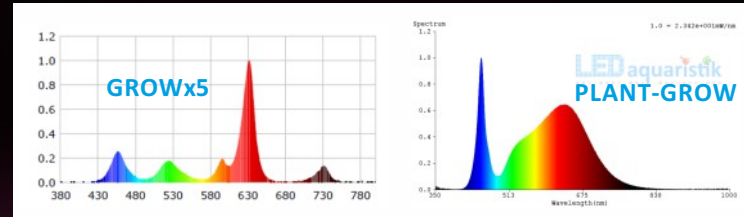

## Working principle of GROWx5 and PLANT-GROW

Photosynthesis is the process that plants use to extract energy from sunlight and eventually grow. The absorption spectrum, i.e. the plant's light uptake, shows that photosynthesis is primarily determined by blue and red wavelengths. However, a broader light spectrum is much more effective than a narrow-band light spectrum with only blue and red. For this reason, GROWx5 and the PLANT-GROW go one step further.



# UVA / SKY-GROW as PRO<sup>2</sup> LED bar: UV light + plant light = full spectrum 2.0

This LED bar with its highly specialised light colours was developed for advanced users. Two independently controllable channels with UV light on the one hand and SKY-GROW light on the other make it an extraordinary full-spectrum lamp whose mixing ratio can be adjusted to the situation by light control. The UVA / SKY-GROW should never be used as the sole light source. Ultraviolet light should be used as supplementary lighting and serves to fine-tune the light spectrum as well as for targeted and coordinated growth promotion.

## Plants

Adding moderate amounts of ultraviolet light to the lighting signals to the plant that it is now receiving intensive light. It reacts by synthesising photolyase, i.e. by producing enzymes, proteins and amino acids that are supposed to protect it from UV damage ("sunburn"). The leaf becomes thicker and smaller, the growth becomes more compact and concentrated, as the energy supplied is used to produce the sun protection instead of rapid growth. This protective reaction already shows that UV light should be well dosed.

## Corals

Sunlight is elementary for the corals' food supply, which is why they live in relatively shallow water and are exposed to UVA and UVB light. Unlike conventional HQI lamps, the UVA output of our UV LEDs can be controlled, potentially harmful UVB and UVC is not present. By using UV LEDs at the edge of the visible range with a wavelength of 385nm to 400nm, just enough UV radiation is generated to produce a bluish-purple light that causes the corals to fluoresce and stimulates and optimises photosynthesis within the corals.

**Tips for use:** Glass or acrylic covers can filter out the UV light. Our CleanCovers are UV-transmissive, but the ageing process is accelerated.

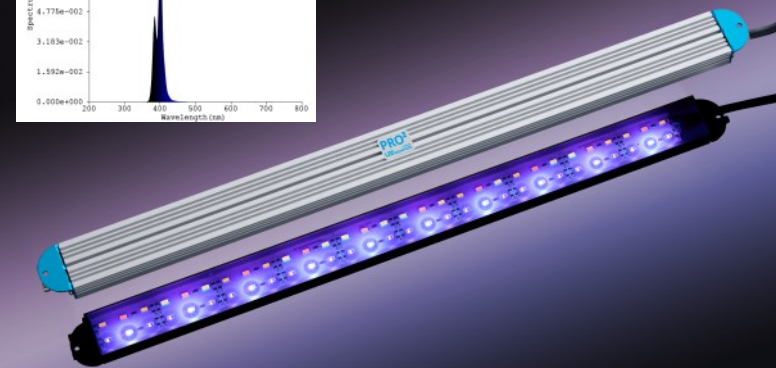
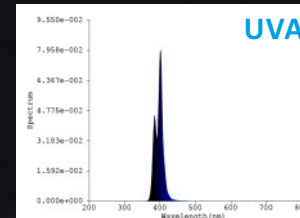
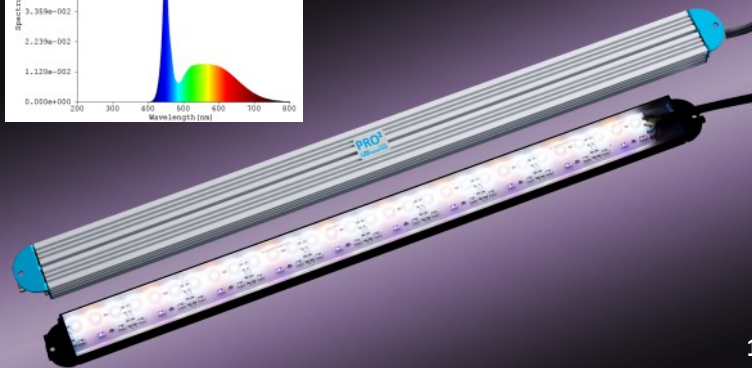
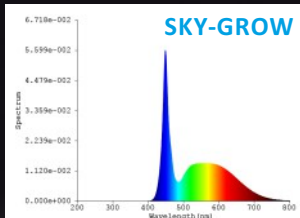

# spotBEAM

The full spectrum LED spot

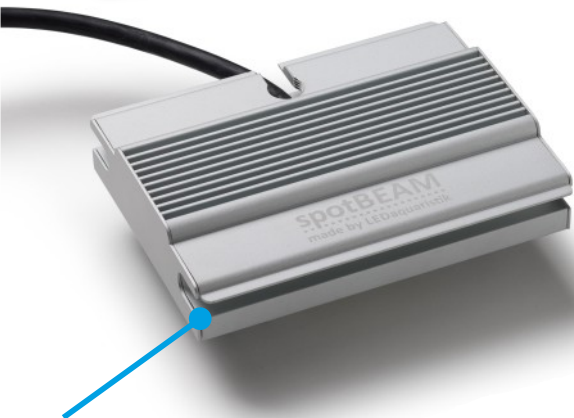

**Solid + passive heat sink  
for silent operation**

Welcome to the captivating realm of spotBEAM LED spotlights, designed to elevate your aquarium lighting experience. With compact dimensions of just 10x12 cm, these spotlights are true powerhouses. Whether you have a small or large aquarium, spotBEAM spotlights offer stunning full illumination or precise spot lighting.

What makes them truly special is each spotBEAM spotlight is equipped with a unique 3-channel COB LED chip, meticulously designed for simulating natural daylight and offering precise dimming control. Choose from the three light compositions – PLANT-MIX, AFRICAN-SUN, and SEAWATER – to create the perfect ambiance for your aquarium.

### **Delving into spotBEAM LED Spotlights**

Unlock the full potential of your aquarium with spotBEAM LED spotlights. Their compact form factor allows for flexible placement, catering to both small and large aquariums. Whether you desire broad, even lighting for your reef tank or targeted spotlighting for captivating underwater landscapes, the spotBEAM has you covered.

The spotlight's crowning jewel is undoubtedly its unique 3-channel COB LED chip, seamlessly blending precise control and emulation of natural lighting conditions. Immerse yourself in the magic of PLANT-MIX, AFRICAN-SUN, and SEAWATER, sculpting a tailored lighting scenario for your aquatic inhabitants.

Installation is a breeze: opt for the optional gooseneck mount for versatile positioning along the aquarium's edge, or seamlessly integrate the spotBEAM with our range of mounting solutions, including deLUX covers, lamp housings, and adapter profiles. To harness the full potential, we recommend pairing spotBEAM with our light controllers such as SunRiser or SIMU-LUX, allowing for personalized adjustment of brightness and color temperature, resulting in a mesmerizing light display.

Dive into the world of spotBEAM LED spotlights and craft a breathtaking underwater landscape that enchants not only your eyes but also the inhabitants of your aquarium.

#### Scope of delivery

- spotBEAM LED spotlight, in light colour and housing colour of your choice
- Cable length 250cm
- Glass lens with 90° beam angle included, other lenses (40°, 60°, 120°) available separately.

**A power supply unit and light control must be ordered separately according to the number and scope of the lighting.**



Especially when all 3 channels are operated

simultaneously at full power, the surface temperature of the cooling or lamp body increases. Caution when touching! Before cleaning and maintenance work, switch off the device and disconnect it from the mains. Never cover the luminaire with objects and make sure that there is always sufficient heat exchange in any case.

#### Technical data

- Chip: COB
- Voltage: 12V DC (direct current)
- LED chip life: ~50,000 hours
- Switching cycles until premature failure: ~100,000
- LEDs not replaceable due to design
- Switch on time: none
- Connection cable approx. 250cm (6x 0,50mm<sup>2</sup>)
- Connections to further accessories will be delivered according to the scope of order
- Protection class: IP67 not suitable for underwater use!
- Dimmable: yes

20



*Photos show optional accessories*

## Technical data



### PLANT MIX

Lumen		Output/consumption		Efficiency	
3.543 lm		26W =26 kWh/1000h		137 lm/W	
Channel 1 (main light)		Channel 2 (moon light)		Channel 3 (sun)	
Power	Light colour	Power	Light colour	Power	Light colour
15 W	6.000K	7 W	465nm / 12.000K 2:1	8 W	2.700K / 630nm 2:1



### AFRICAN-SUN

Lumen		Output/consumption		Efficiency	
3.463 lm		26 W = 26 kWh/1000h		134 lm/W	
Channel 1 (main light)		Channel 2 (moon light)		Channel 3 (sun)	
Power	Light colour	Power	Light colour	Power	Light colour
15 W	8.000K	78 W	465nm / 12.000K 2:1	8 W	2.700K / 630nm 2:1



### SEAWATER

Lumen		Output/consumption		Efficiency	
1.549 lm		27 W = 27 kWh/1000h		58 lm/W	
Channel 1 (main light)		Channel 2		Channel 3	
Power	Light colour	Power	Light colour	Power	Light colour
11 W	20.000K	12 W	465nm	8 W	405, 450, 425nm



## Optional spotBEAM accessories

### Mounting set "Gooseneck"

for mounting e.g. on the edge of glass



In heavy, stable design.

Suitable for glass thicknesses of up to 15mm with vertical or horizontal mounting.

Length gooseneck: 485mm

Materials:

Gooseneck steel, silicone coated.

Clamping piece anodised aluminium

Clamping screw plastic (nylon)

**When mounting, the short thread of the gooseneck goes to the spotBEAM, the long thread to the clamping piece.**

**The cable is fed through the gooseneck!**

### Alternative glass lenses

If required, the 90° lens included in the standard scope of delivery can be replaced by an alternative lens with a beam angle of 40°, 60° or 120°.

Tip: The smaller the beam angle, the stronger the curling effect. The larger the

The larger the beam angle, the more homogeneous the effect of the different light colours.

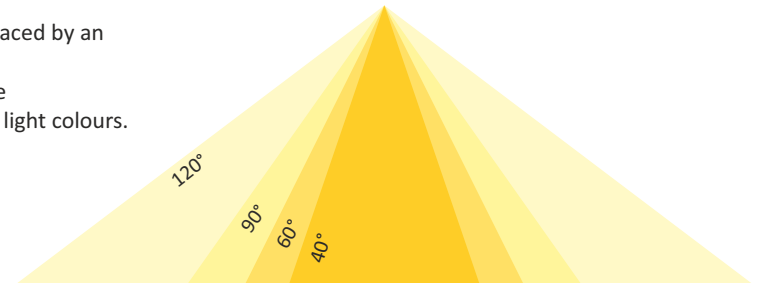

# aquaLUMix

Top-quality LED compact light



Full spectrum  
LED

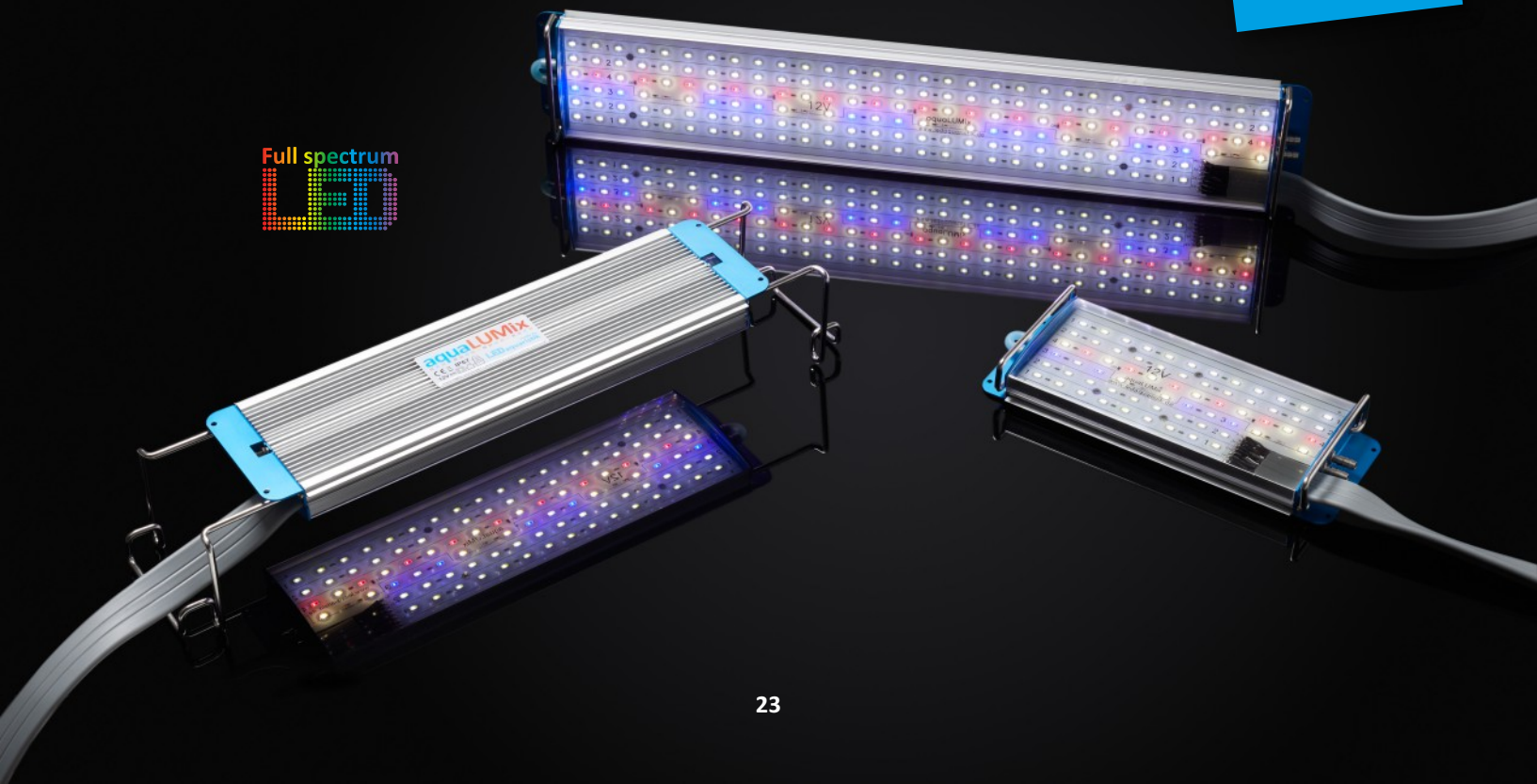



Explore the world of perfect lighting for your home aquarium with the innovative aquaLUMix LED bars. Leveraging our extensive expertise in LEDaquatics, we offer you a comprehensive range of top-tier lighting solutions tailored to your specific needs.

## The Perfect Color Combination for Your Aquarium

According to your preferences and your aquatic inhabitants' requirements, we offer four distinct color combinations:

**FRESHWATER:** Crisp light colors with excellent color reproduction, ideal for classic community tanks.

**AMAZON-GROW:** Bright tropical light with a focus on optimal plant growth, including dedicated Grow LEDs.

**AFRICAN-SUN:** Elevated blue spectrum in daylight, combined with color-enhancing light, perfect for cichlid tanks.

**SEAWATER:** Strong blue-dominated light with additional colors like red, violet, and UV for saltwater aquariums.

Our aquaLUMix LED bars are equipped with 4 separately controllable light channels, offering you endless possibilities in lighting. Whether you want to replicate natural daylight or create dramatic effects such as moonlight and sunrise, aquaLUMix gives you complete control.

Available in 24, 34, 54, 74, 89  
115 and 144cm length

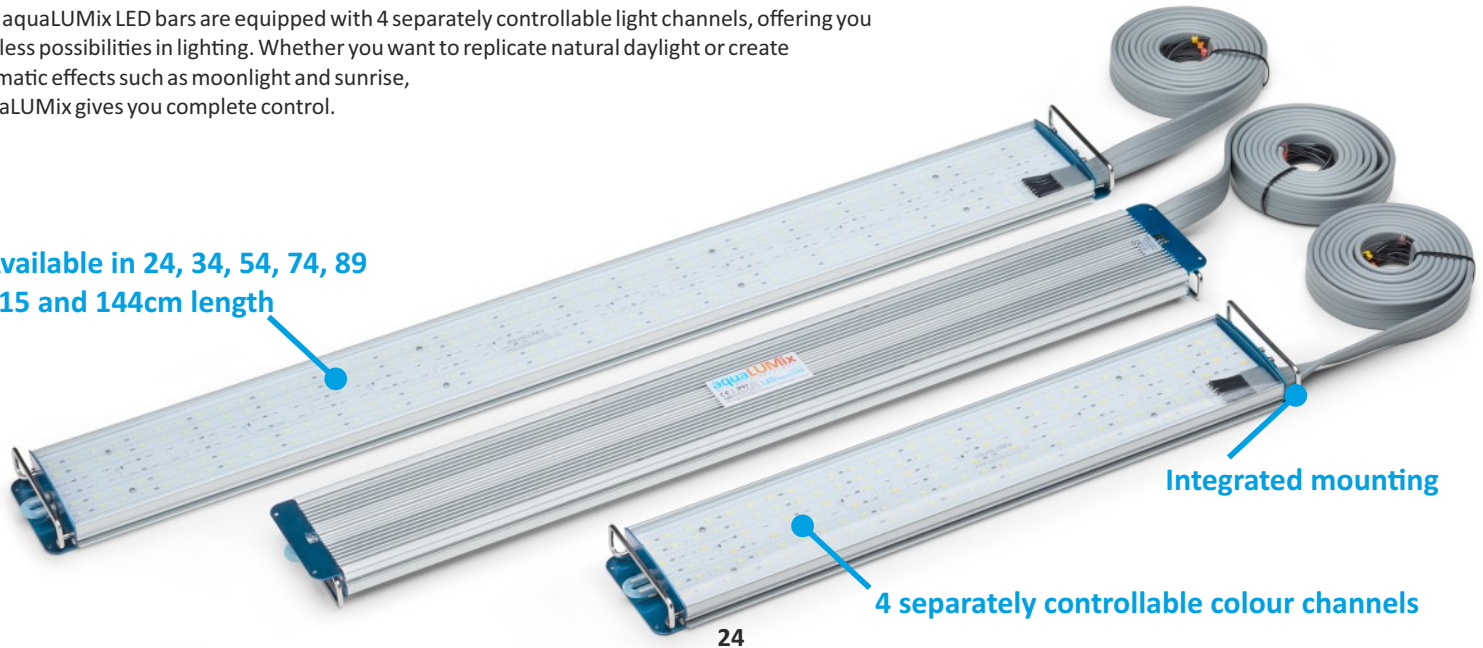

## Highest Performance and Flexibility

aquaLUMix LED bars utilize proven high-power LEDs of the latest generation. With up to 498 individual LEDs, they offer more light than most other aquarium lights available on the market. The sophisticated design guarantees reliable and long-lasting performance. Thanks to full dimming capabilities and separate channel control, you can craft your own unique lighting scenarios.

**HIGHLIGHT** - aquaLUMix LED bars don't just provide impressive lighting; they also optimize heat dissipation. The temperature-optimized aluminum profile allows for effective passive cooling, while the optional water cooling efficiently cools the LEDs and heats your aquarium simultaneously.

See page 33.

## Easy Installation and Stylish Design

aquaLUMix LED bars are incredibly versatile and easy to install. The factory-adjustable bracket allows for hanging or placement. Alternatively, various brackets are available for customized mounting. The optically optimized CleanCover not only shields the LEDs but also widens the beam angle to up to 180°, creating a natural shimmer effect on the aquarium floor.

The lateral blue mounting brackets with holes are also suitable for individual mounting.

In addition, the aquaLUMix is compatible with the deLUX aquarium cover as well as with our stylish lamp housing in the colours black and silver for use as a pendant, floor-mounted or top-mounted luminaire. Of course, the LEDaquaristik adapter profiles for JUWEL and EHEIM aquariums can also be used for mounting the aquaLUMix lamp.

Experience aquaLUMix LED bars: The perfect fusion of top-notch lighting, flexibility, and premium design for your aquarium.

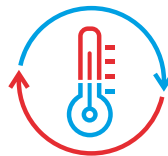

Standard

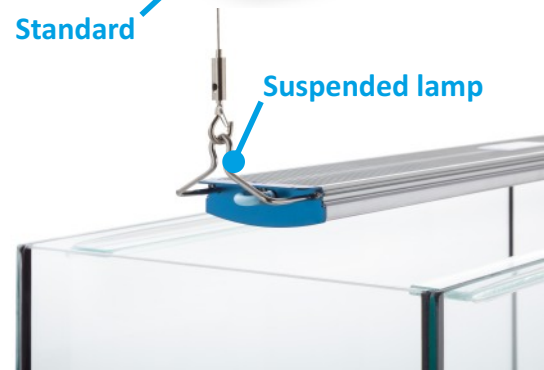

Suspended lamp



Side-mounted lamp

## Dimming and simulation

Of course, the aquaLUMix can be dimmed without restriction and has 4 separately controllable channels for the main lighting including integrated effect colours to simulate e.g. moonlight and sunrise and sunset.

To make the most of the aquaLUMix's full range of features, we recommend using one of our lighting controllers, e.g. SunRiser 6 or SunRiser 8, so that the brightness of each individual channel and the resulting colour mix of the entire lamp can be adjusted individually. There are almost infinite possibilities thanks to the infinitely variable SunRiser light controls.

Alternatively, our manual 6-channel dimmer DIMIX6 offers the possibility of infinitely variable dimming and mixing of light colours via slider.

**Whether automatic SunRiser light control or manual DIMIX6 dimmer - the dimming curve is always stepless, flicker- and jerk-free.**



DIMIX6 page 42



SunRiser 6 page 77

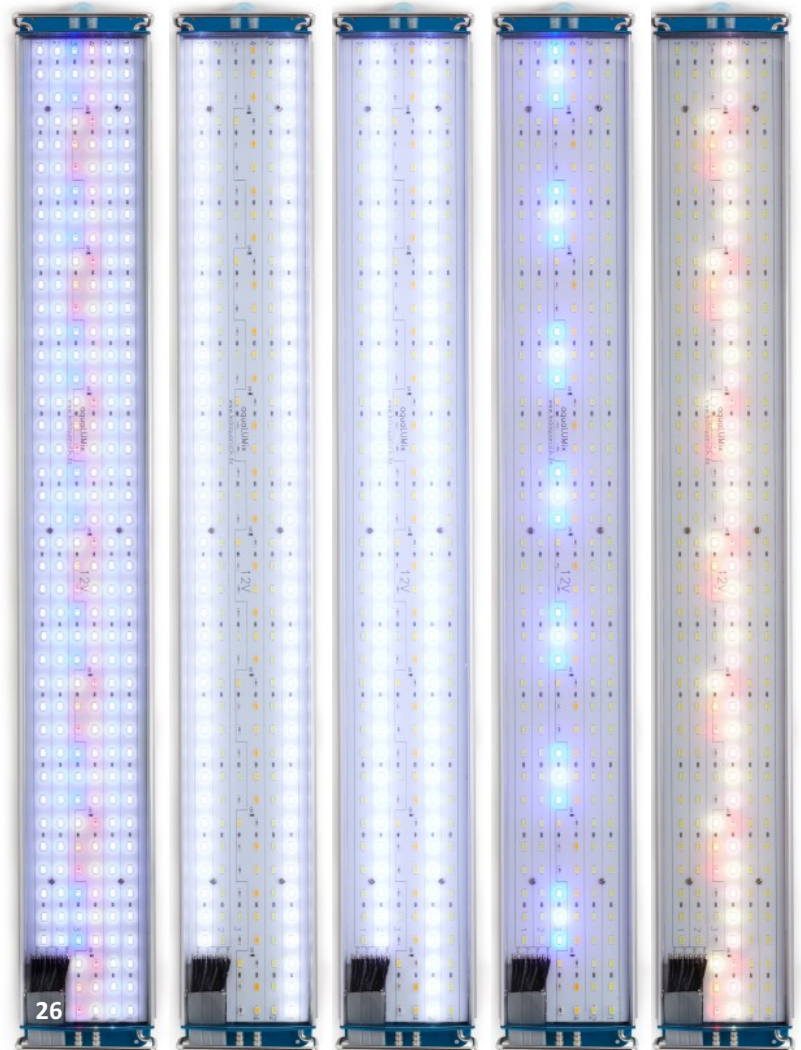

## Quality

The imposing and solid aluminium lamp body has a high-quality finish and shows its value through its weight alone. At the same time, the aquaLUMix is slim and unobtrusive in its dimensions. All aluminium parts of the lamp are anodised and thus have the best surface protection. All other screws, mounting parts and brackets are made of rustproof V4A stainless steel.

The LEDs are sealed watertight inside the lamp by ClearSealing: UV and temperature stable! This means that the aquaLUMix will survive even accidental submersion in water without damage.

The already mounted CleanCover is a splash guard made of highly transparent, ultra-thin and impact-resistant plastic. It additionally protects the aquaLUMix from limescale and dirt deposits and is very easy to clean.

The connection cable is a particularly high-quality and rubberised 8-core flat cable with a length of 250cm. (2 cores +/- per channel)

**Also available as complete set incl. power supply unit and light control.**



**Integrated water cooling**



**250cm cable**



**Massive aluminium body**

## Technical data

The following data refer to the "aquaLUMix FRESHWATER" variant as an example, other variants and light colours may vary!

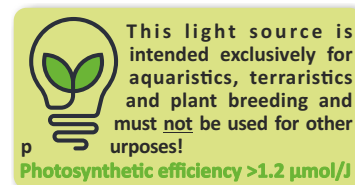

Variant	LxWxH (mm)	LEDs	System output	Lumen	Efficiency	Energy consumption	Ra/CRI	PAR/PPFD at 30 cm
144 cm	1434x98x28	498 pcs	152 W	19.176 lm	129 lm/W	152 kWh/1000h	86,2	279 [μmol/m <sup>2</sup> s]
115cm	1144x98x28	390 pcs	127 W	16.218 lm	130 lm/W	127 kWh/1000h	87,3	297 [μmol/m <sup>2</sup> s]
89cm	884x98x28	300 pcs	101 W	13.198 lm	132 lm/W	101 kWh/1000h	87,6	295 [μmol/m <sup>2</sup> s]
74cm	734x98x28	246 pcs	92 W	12.102 lm	132 lm/W	92 kWh/1000h	86,6	294 [μmol/m <sup>2</sup> s]
54cm	534x98x28	174 pcs	72 W	9.433 lm	117 lm/W	72 kWh/1000h	86,6	259 [μmol/m <sup>2</sup> s]
34cm	334x98x28	102 pcs	46 W	5.978 lm	113 lm/W	46 kWh/1000h	87,0	182 [μmol/m <sup>2</sup> s]
24cm	234x98x28	66 pcs	31 W	3.992 lm	101 lm/W	31 kWh/1000h	87,7	119 [μmol/m <sup>2</sup> s]

Further data and diagrams on the light spectrum are available in the product description under ("Data sheet & key figures") of the respective LED bar.

*\*The light measurement of the product was carried out according to the scope of delivery and light control in a dry environment at 100% output. The use of dimmers, light controls, other power supplies, focusing lenses, protective covers or reflectors may lead to deviating results. In addition, slight deviations from the test sample may occur due to the batch. PPFD - Photosynthetic Photon Flux Density. PAR - Photosynthetically active radiation. PPE - Photosynthetic photon flux per watt of electrical energy.*

Beam angel	120°, effective 160° due to ClearSealing
Voltage	12V DC (direct current)
LED chip service life	~50.000 h
Switching cycles	until premature failure: approx. 100,000
Light souce	LEDs not replaceable due to design.
Switching time	none
Ingress protection class	IP67 – not suitable for underwater use!
Dimmable	yes
Cooling	Passive via solid aluminium heat sink Alternatively by water cooling

## FRESHWATER

Clear, bright colours for outstanding colour rendering, without being detrimental to plant growth. (e.g. for the classic company aquarium)



aquaLUMix

## AMAZON GROW

A bright, tropical light with a focus on optimum plant growth, including Grow LEDs. (e.g. for thickly-planted Amazon or Asian aquariums)



## AFRICAN SUN

A higher proportion of blue in the daytime light, augmented by a colour-intensifying light composition. (e.g. for cichlid aquarium with Malawis or Tanganyikas)



## SEAWATER

Basically, a high proportion of blue with white and blue light, with additional special colours like red, violet and ultraviolet. (For seawater aquariums)



Questions? Perhaps you will find the answer in our FAQ: <http://faq.ledaquaristik.com>

**Which LED bars or light colours should I choose, especially for light control / day simulation?**

**Module system eco+/PRO<sup>2</sup>**

Even with 2 light colours, an appealing daytime sequence is possible, e.g. SUNSET and DAY. SUNSET is used for sunrise and sunset, DAY is switched on for the main lighting. For higher lighting requirements, a colour combination of SUNSET, DAY, POLAR (or optionally TROPIC, DAY, SKY) is a good choice, as the colour spectrum is well and widely covered. Our experience with these combinations and planted aquariums has been very good. In addition, these light colours are ideal for daylight simulation. So this is a recommendable standard configuration. Whether you use 3 light rows and colours or leave it at 1-2 depends on your lighting needs. Depending on the requirements, additional effect colours (RED = dawn, ROYAL BLUE = moonlight) could be combined. However, an extension would also be possible at any later time without any problems. (Provided the appropriate power supply unit is available)

**aquaLUMix compact system**

With the aquaLUMix, the question of the best colour choice no longer arises, because we have already equipped these compact luminaires with the optimum light composition based on years of experience. Depending on your aquarium in terms of stocking, furnishings and personal taste, you can choose one of 4 colour combinations, a suitable solution for all areas: FRESHWATER, AMAZON-GROW, AFRICAN-SUN and SEAWATER. Each of these aquaLUMix is equipped with 4 separately controllable light channels, which open up incomparable lighting possibilities. In addition to light colours for general daylight illumination, LEDs for moonlight and sunrise are already integrated.

**Further questions and answers under <http://faq.ledaquaristik.com>**

**We will also be happy to help you personally: Mon.-Fri. 8:30-12:00 and 13:00-16:30  
Email: [support@ledaquaristik.de](mailto:support@ledaquaristik.de) | Live-Chat on [www.ledaquaristik.de](http://www.ledaquaristik.de) | Phone: 05257/9366650**

## Reflector - Shutter - Mirror unit for aquaLUMix

This reflector for our aquaLUMix serves as a glare shield and maximises the lighting intensity, especially in the front or rear edge areas of the aquarium. Precisely fitting in size and colour, it blends in perfectly with the design of the aquaLUMix: Anodised aluminium-grey on the outside, with a highly reflective mirror on the inside.

Installation is very simple, the reflector is hooked into the aquaLUMix and fixed in place with the screws provided. But please note: When using the aquaLUMix in our adapter profile, lamp housing or support profiles, it is not possible to use the reflector.

### Is the reflector used on both sides, only on the front or only on the back?

When used on the rear side, the decisive benefit is the reflection of the light and thus the increased brightness in the rear area of the aquarium. The scattered light is effectively used by the mirror unit and fed to the background planting, which is otherwise not optimally illuminated. The mirror also reveals a completely new angle of view of the aquarium, quasi a top view from a comfortable position.

If the reflector is used on the front, it also serves as a glare shield. This is particularly pleasant and advantageous for observers in a sitting position or children in front of the aquarium.

With reflectors on the front and back, the efficiency of the aquaLUMix is increased to the maximum. Even when using the aquaLUMix in a hanging position, we recommend using it on both sides so that the lamp hangs level and is balanced.

### Scope of delivery:

- 1 piece reflector according to the selection.  
(For use on both sides, 2 pieces must be selected).
- Fixing screws

Total height of the lamp (without holder) with reflector: 5cm





2x reflector: for light optimisation and as glare protection

1x Reflector: For optimising the background planting.

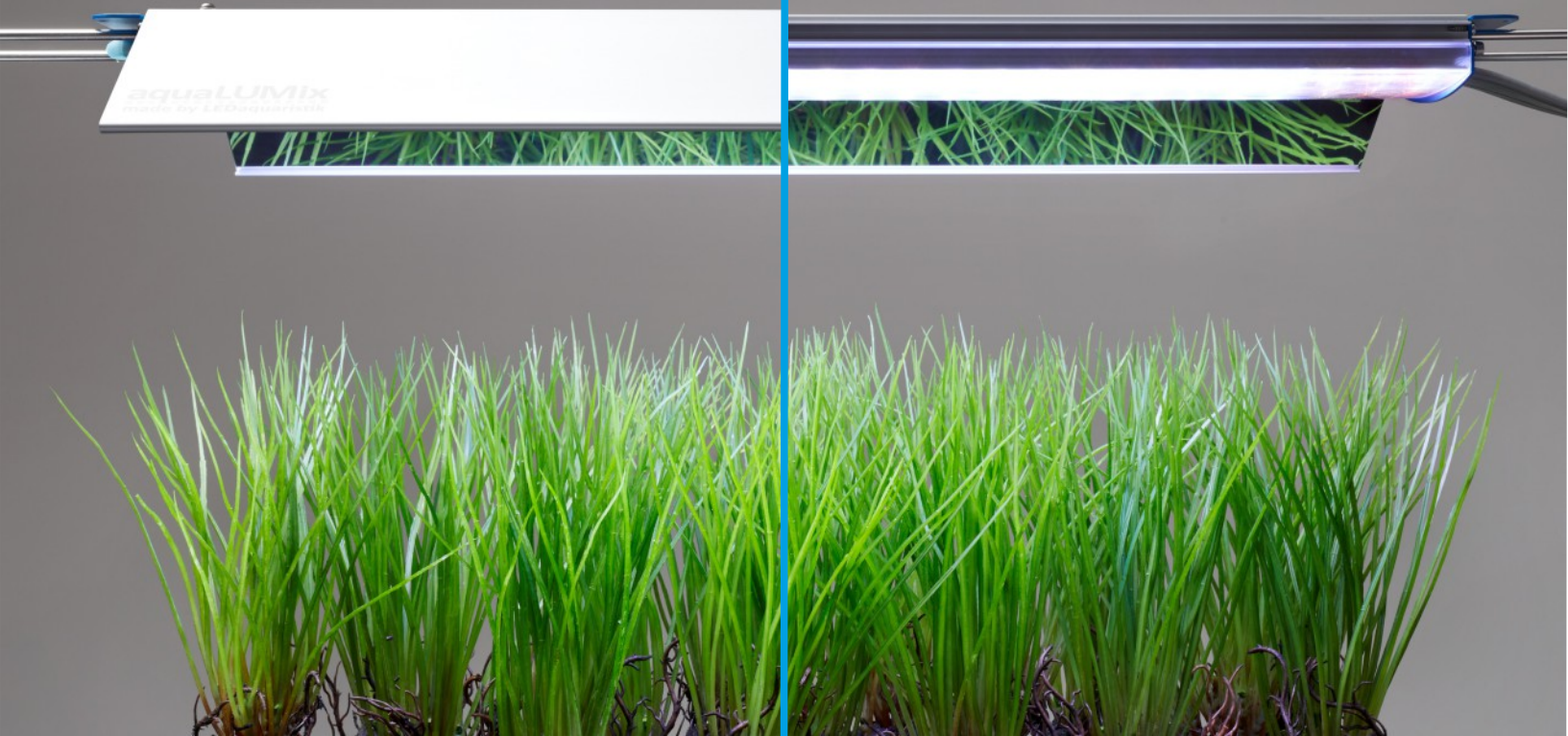

## Heat Recovery by Water Cooling

LED water cooling offers several benefits. Firstly, it ensures optimal cooling for the LED bars and effectively uses their waste heat to warm the aquarium. LEDs, whether used at home or in aquaristics, lose luminosity over time. The indicated LED lifespan, such as 40,000 hours, means that the LED will only have 50% of its original brightness after this period. Proper cooling can significantly mitigate this decline in performance.

**Although the temperature-optimized aluminum profile already allows for passive cooling, active water cooling is often superior. Water cooling channels the heat energy, which is wasted in traditional LED bars, into the aquarium water, thereby reducing the load on the aquarium heater. This makes LED water cooling with heat recovery a significant advantage for aquarists.**

### Advantages:

- ✓ Optimal Temperature Control: The LEDs operate within the optimal temperature range to maximize luminous duration and performance.
- ✓ Heat Recovery: The LED water cooling utilizes the waste heat from the LEDs to supply warm water to the aquarium.
- ✓ Energy Efficiency: The power consumption of the aquarium heater is significantly reduced. LED bars with heat recovery pay off much faster.
- ✓ Efficient Water Cooling: Two integrated XL channels for water cooling provide high flow rates, excellent cooling properties, and maximum efficiency. The system is virtually maintenance-free.
- ✓ Flexibility: Connect the water cooling of several PRO<sup>2</sup> LED bars together.
- ✓ Noiseless Operation: Our system offers noiseless operation for an undisturbed aquarium experience.

### Special Features:

- ✓ Integrated Water Cooling: Our aluminum profile allows unhindered heat exchange between LED and cooling water, while competitors have lower efficiency.
- ✓ High-quality Construction: The XL channels carry 56% more water for superior cooling properties. Easy accessibility simplifies cleaning. Silicone hose and 180° bend are made of high-quality material for durability and shape stability.



*\*Exemplary values:  
Room temperature, heater, water  
volume, etc. must be taken into account and  
lead to individual results.*



**Calculate heat output:**  
<http://faq.ledaquaristik.com>

## Water cooling connection:

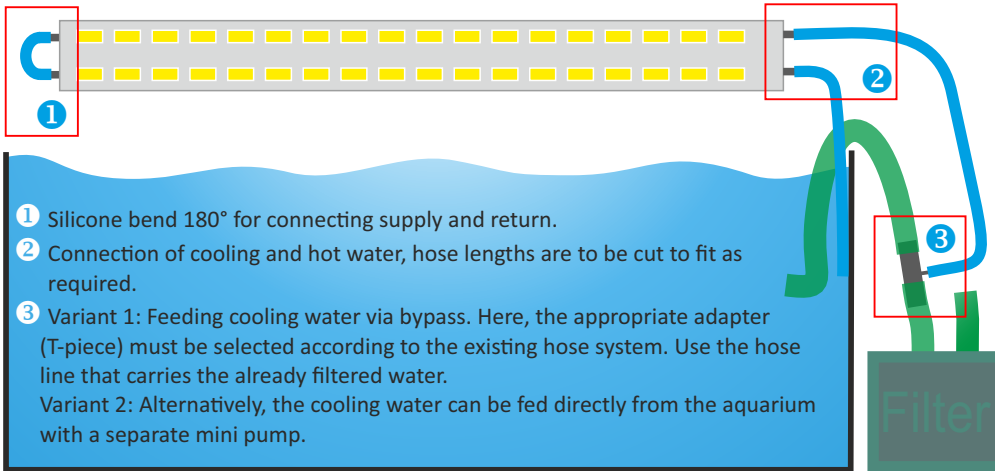

- 1 Silicone bend 180° for connecting supply and return.
- 2 Connection of cooling and hot water, hose lengths are to be cut to fit as required.
- 3 Variant 1: Feeding cooling water via bypass. Here, the appropriate adapter (T-piece) must be selected according to the existing hose system. Use the hose line that carries the already filtered water.  
Variant 2: Alternatively, the cooling water can be fed directly from the aquarium with a separate mini pump.



## Mini pumps for running the water cooling system

These small and very economical pumps supply the water cooling system with aquarium water for cooling.

Two variants are available:

The 230V pump for conventional operation at a socket.

The "12VDC controllable" variant allows the pump to be connected directly or indirectly with the power supply of the LED lighting. In addition, this pump is compatible with our lighting controls and can be operated with them. This makes it possible to use the pump in a time-controlled manner (e.g. switch off at night). It is also possible to dim/throttle the pump output (flow rate). Optionally, a separate channel of the control unit can be used for the pump, or alternatively, a channel already occupied by an LED bar can be shared.



**For the operation of the 12VDC pump on a light control (SunRiser 2+, 2XL, 6, 8 or SIMU-LUX), the supplied connection cable is mandatory. The polarity of the connection must also be strictly observed (red=PLUS, black=MINUS)! It is not possible to operate the CO2 valve and the mini pump at the same output of a light control unit and this can lead to a defect in the light control unit.**

**Tip: Install the pump so that the suction opening does not point downwards - otherwise disturbing noises may occur.**



## Cleaning the cooling system by air

Depending on the quality of the aquarium water, regular maintenance / cleaning of the water cooling system is recommended to ensure the best possible function at all times. With this air pump, the system can be "blown through" quickly and easily without having to disconnect hoses, etc.

We recommend doing this regularly to prevent stubborn contamination.

As a supplement and for coarser use, suitable cleaning brushes made of stainless steel are also made of stainless steel are also available.



## Seawater - TITAN Upgrade

Compared to fresh water, seawater is extremely aggressive and would permanently damage the aluminium of our LED luminaires if the water cooling system was not used.

The optional TITAN extension for a seawater application of the water cooling system contains two titanium tubes, made of 100% pure titanium, which are inserted into the cooling channels of the lighting. Contact between aluminium and seawater is thus excluded. The titanium tubes are 100% resistant to seawater.

The installation is very simple. The four existing hose connections are to be removed/screwed off. The titanium tubes are pushed in, the hoses are pushed on and additionally secured with the enclosed hose clamps.



## CO2 Druckminderer und Diffusor

This pressure reducer for CO2 regulation is optimised for switching through our light controls (SunRiser & SIMU-LUX).

The **pressure reducer** consists of a working pressure gauge and a bottle pressure gauge. This means that not only can the working pressure be regulated down to the desired level, but the pressure in the bottle is also displayed, making it easy to see when it is time to refill. A bubble counter is integrated for visual control of the inflowing Co2.

The solenoid valve can be switched with our light controls (0%=closed, 100%=open), and can only be used with a voltage of 12VDC. The solenoid valve is connected like an LED to one of the outputs of the control unit.

Thread/bottle connection Standard: W21.8

Material: blue anodised aluminium



Thanks to its fine ceramic membrane, the stainless steel **CO2 diffuser** dissolves up to 98 % of the supplied CO2 in the aquarium water. The resulting tiny CO2 bubbles spread easily and are ideally absorbed by the aquarium plants.

The recommended working pressure is 1.5 bar (22 psi).

**Tip:** It may take several hours before the ceramic membrane is optimally flushed and the CO2 bubbles are released, as the membrane must first adjust or "soak". You can speed up this process by soaking the **membrane in a water bath for one night before use.**



**It is not possible to operate the CO2 valve and the mini pump at the same output of a light control unit and this can lead to a defect in the light control unit.**



## Accessories [More at www.ledaquaristik.de/Zubehoer](http://www.ledaquaristik.de/Zubehoer)

LED Splitter. This splitter makes it possible to operate up to 6 LED bars with only one power supply unit.



With a length of up to 90cm, these very robust and high-quality tongs are particularly suitable for larger systems where your own arm is no longer sufficient.

Various individual parts helpful for individual assembly or as replacement.

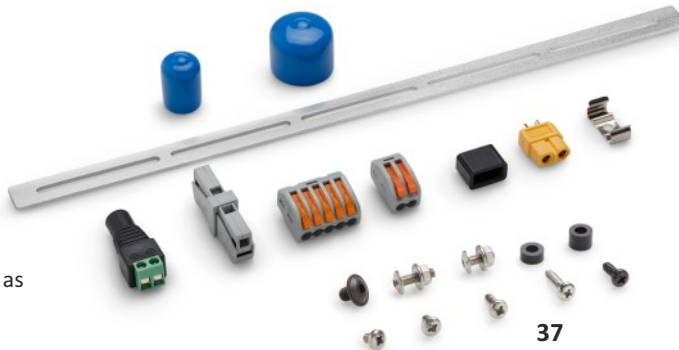

37



Fish transport bags are available in the sizes 180mm x 500mm and 250mm x 600mm, packaging unit 100 pieces.

## Verbinder zur Kabelverlängerung

**Heat-shrinkable soldering connectors for extending connection cables: Connecting - soldering - insulating - sealing - in one simple operation.**

**Child's play!** All without soldering iron and solder. You get a waterproof and better durability than with crimp connectors or luster terminals.

**Instructions:** Remove approx. 5mm of insulation from the cables to be connected. Now twist the stripped cable ends and insert them from both sides into the solder connector until the bare ends are parallel under the silver ring of solder in the middle of the connector. Heat the soldering connector evenly to approx. 110°C (at best with a hot air blower, with caution also with a lighter or similar). The soldering connector starts to narrow and sticks to the cable. Now let the solder melt completely and then hold the cables in position until the solder has cooled down and become solid. You can visually check the connection thanks to the transparent heat shrink tubing. As an additional protective measure and to make the connection visually inconspicuous, now shrink the entire connection with the enclosed black shrink tubing. This is coated on the inside with an adhesive, which ultimately ensures an absolutely tight connection. DONE.

Matching: Rubberised premium cable by the metre for individual extension of the connecting cables of our LED bars.

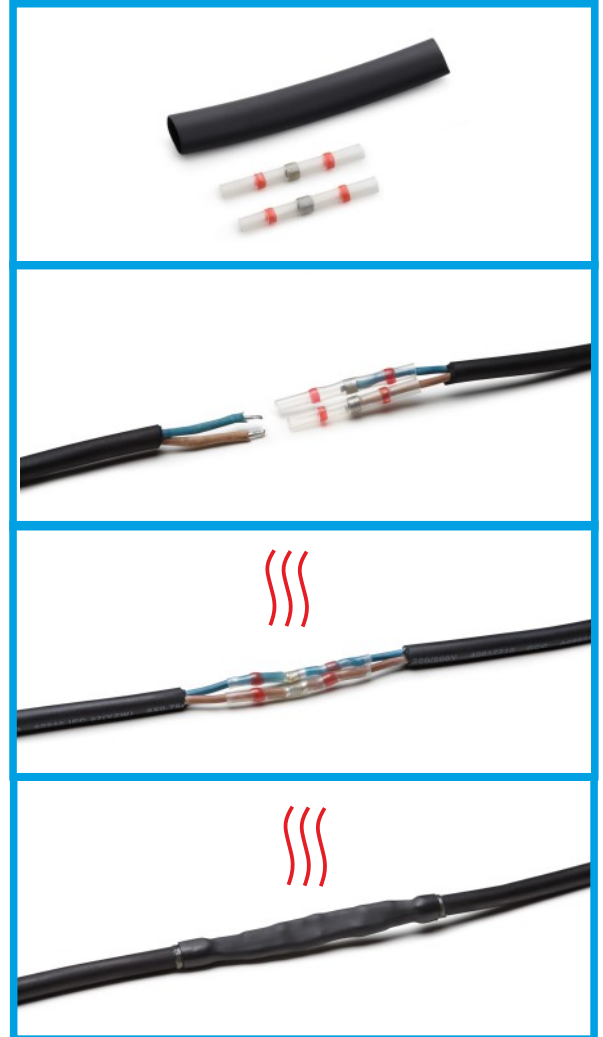

# High performance LED switching power supplies for the operation of our LED bars (12VDC)

An extremely high-quality LED switching power supply that sets standards in quality and performance. High-quality workmanship, solid design in aluminium housing, durability, high efficiency and low heat generation. This excellent LED power supply puts the usual plastic desktop power supplies in the shade and is therefore our clear recommendation to buy!

These power supplies\* are compatible with all lighting controls\*, dimmers\* and distributors from our range.

\*Please note the maximum connected load!

## What power is required?

This is how it is calculated: To determine the power the power supply unit must have, the power values (watts) of the desired LED bars are added, plus a min. 10% power reserve. The next larger power supply unit is then the correct choice. To avoid overloading the power supply unit, always allow for a power reserve of at least 10%! (Our computer automatically takes this into account!)

To avoid misunderstandings: The power supplies themselves do not consume 35, 100 or 150W of power! But they are capable of delivering this power! The power consumption depends solely on the connected LEDs and the efficiency of the power supply! In idle mode (i.e. when the power supply unit is only plugged into the socket, not connected to LEDs or in operation) it only consumes approx. 1W.

## Technical data:

- Input voltage 85 ~ 265 VAC
- Output voltage: 12 VDC
- Output power: depending on selection: 35W to 264W
- Frequency: 47 ~ 63 Hz
- Efficiency >90
- Aluminium housing, Ip67
- Protected against short circuit, overload protection
- Cooling by natural convection
- Working temp. at -40 to + 70° C
- Cable lengths:
  - 230V input 50cm with EU Schuko plug,
  - 12V output 50cm (connection according to scope of order)



Calculate the correct power supply unit: <http://power-supply.ledaquaristik.com>



## Observe overvoltage protection!

Even if one immediately thinks of a thunderstorm and a lightning strike, overvoltage damage to LED lighting usually has other, less noticeable and insidious causes.

A lightning strike leads to a short-term overvoltage and immediate failure and irreversible defect of the lighting. Cause and effect are immediately and clearly recognisable. But there is also the long-term overvoltage. This remains unnoticed at first, but significantly impairs the service life of the LED lighting until visible damage and progressive failure occurs after only a few weeks and months.

Voltage peaks in the nanosecond or microsecond range, i.e. short-term increases in the mains voltage caused by switching operations in the electrical circuit or electrostatic discharges, can sometimes reach well over 10,000 volts, although only for fractions of a second, but this is already enough to irreparably damage LED modules, electrical components or power supply units.

The exact effect of such an event on the mains in your house and consequently on the LED lighting depends on the type of installation and the protective circuits installed by the electrician.

Our LED lighting can easily reach the value of a computer or television set, so you should also protect them at least equally against overvoltage. Damage to LED lighting caused by overvoltage is expressly not covered by the warranty. This is why the EMZ 504 broadband mains filter with overvoltage protection is our recommendation in the event of an unclean mains supply and/or overvoltage problems, or should also be seen as a kind of "insurance" as a preventive measure.

**Further information under [www.ledaquistik.de/mains-filter](http://www.ledaquistik.de/mains-filter)**



## Manual 1 channel LED dimmer

With manual stepless LED dimmers, the brightness (and thus also the power consumption) of the LED bar(s) can be manually adjusted with a rotary knob or remote control.

These dimmers are designed for a maximum output power of 360 watts (30A), so a maximum of 12x 100cm LEDs can be dimmed from 0-100%. All power supplies up to and including 264W power, as well as the LED splitter are compatible with these dimmers.

Technical data:

- Input voltage: DC12V-24V
- Dimming control: PWM
- Connection input/output: Screw terminals
- Dimensions:
  - L85xW62xH35 mm with rotary knob
  - L85xW62xH20 mm with remote control
- Weight: 132g
- Working temperature: -20 to +70°C
- Power consumption: <1W
- Output voltage max. 30A / 360W(12VDC)



**Connection:**  
IN/INPUT: power supply unit  
OUT/OUTPUT: LED



### Variant with remote control

Function: up, down, on/off

Info: When switched on again, the dimmer starts with the last brightness value set.

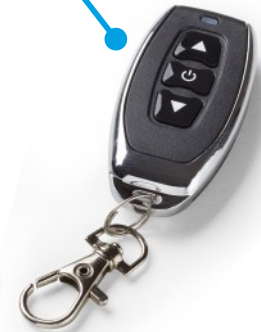

## Manual 6 Channel LED Dimmer & Mixer



**For all those who prefer it simple and without automatic control, who want to change and re-mix the lighting as required at any time.** DIMIX6 is a manual 6-channel dimmer that offers you 6 sliders for stepless dimming and mixing of the connected LED bars and light colours.

### Technical data:

- Suitable for a maximum of 48W (4A/12V) power per channel - multiple use up to maximum possible.
- Possible total power channel 1-6 maximum 264W (22A/12V).
- Dimensions LxWxH: 140x110x30mm

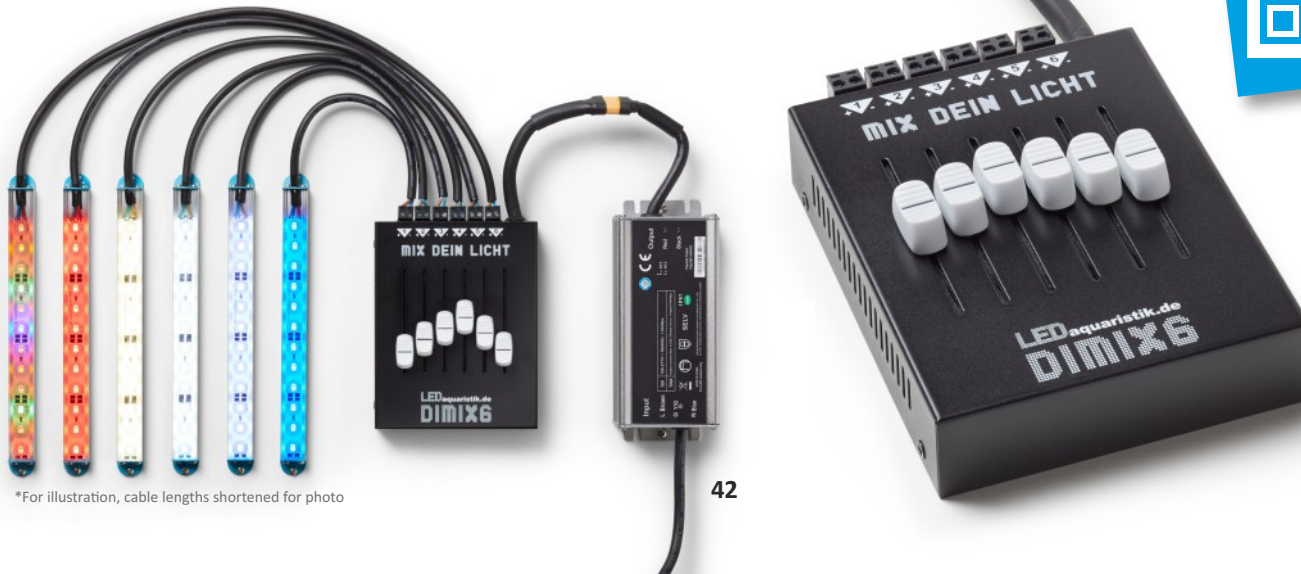

\*For illustration, cable lengths shortened for photo

## CleanCover

The optional CleanCover provides splashwater protection and is made of highly transparent, ultra-thin, impact-resistant plastic. It also protects your LED bars from limescale and dirt deposits and is very easy to clean.

Recommended where LED bars are used within a closed, moist cover or on open aquariums without cover plates.

### Advantages and characteristics:

- **Click&Go** - quickly installed and removed without the need for tools
- Manufactured out of glassfibre-reinforced polycarbonate (PC). The material is impact-resistant, flexible, ultra-thin, UV-stable and **highly transparent**.
- Keeps limescale and dirt deposits off the LED bar.
- Makes cleaning simple and problem-free, with no risk of damaging the silicone coating.
- **Also suitable for use with mounting clips.**
- **Installation:** CleanCover clicks into the longitudinal groove in the LED bar. If mounting clips are used, CleanCover runs smoothly OVER them. Then the protective film must be removed.

Best protection

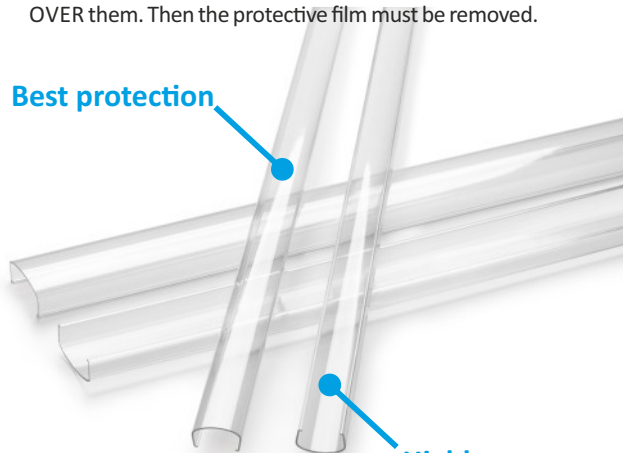

Highly transparent

### Cleaning advice / tips:

- Wash CleanCover with lukewarm water.
- Dirt and other deposits can be removed with a soft cloth or sponge. A microfibre cloth moistened with plain water cleans well and is largely scratch-free.
- Other suitable methods: Household cleaners such as vinegar (acetic acid)/vinegar essence diluted in water, mild soap solutions (detergents) or plastic cleaners approved for use on PC
- Rinse with water and dry with a soft cloth to avoid water marks.
- Any mechanical cleaning system, e.g. brushes etc., is not suitable because it will scratch the surface. The use of corrosive cleaning materials and sharp-edged objects must be avoided because they could damage or scratch the surface. Cleaners containing solvents can cause the surface to become matt.



*Compatible with all our LED bars, including previous models.  
Already included with the aquaLUMix!*

## Silicone feet

The feet (2 per set) enclose the LED bar precisely and can be moved freely on it. Made of transparent and non-slip silicone, they give the LED bar a firm hold. This makes it easy to place the LED bar, for example, on the transverse or longitudinal struts or on the cover pane.

**Of course also suitable for use with a CleanCover. To protect the silicone seal of the LED bars, the feet should only be used in conjunction with a mounted CleanCover on the LED bar.**

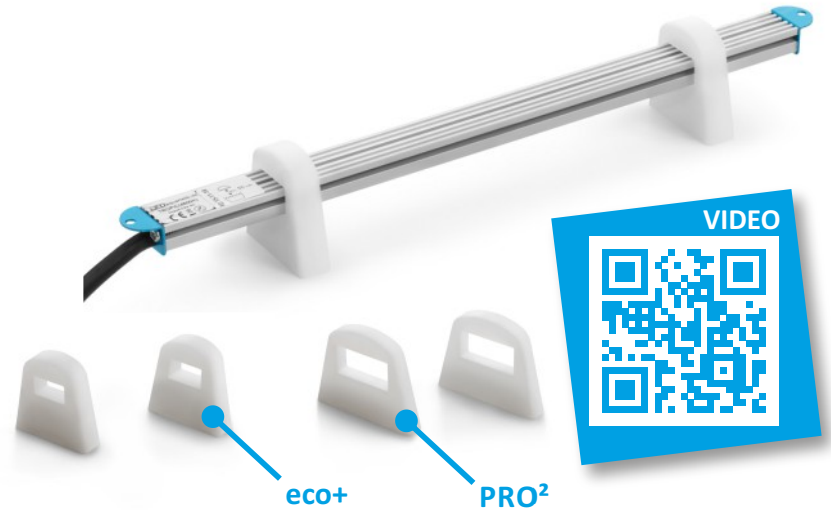

## Bracket holder for PRO<sup>2</sup> LED bars

This minimalist holder made of stainless steel can be used as an alternative for water cooling of the PRO<sup>2</sup> LED bars. Also compatible for mounting in the frame profiles of the deLUX and pure covers. Total length 20cm for a continuous length adjustment of approx. 15cm per side.

To use and mount the bracket holders, the hose nozzles of the PRO<sup>2</sup> LED bars are removed and the bracket holders are inserted into the free channels instead. The possibility of water cooling is no longer given!

Total height of LED bar with holder: 3cm



# The holders to allow our LED bars to be mounted in your existing waterproof tube sockets.

There are two versions available, one for T5 and one for T8 sockets:

**1 Set SOLO: For one LED bar per tube**

**1 Set DUO: For two LED bars per tube (only eco+)**

The holders are all the same length and can be withdrawn from the socket to the appropriate extent. The table below shows which fluorescent tubes can be replaced by which LED bars. A small refinement is that the LED bars including the holders may be rotated through 360° in the tube sockets. In this way you can set a special lighting accent, such as highlighting the back of the tank etc.

Fluorescent tubes (Length in mm)	...compatible with...	eco+ LED bars with solo & duo holders	PRO <sup>2</sup> LED bars only with solo holders
361 to 438	→	20cm, 30cm	/
549 to 590	→	20cm, 30cm, 50cm	47cm
849 to 895	→	50cm, 80cm	47cm, 67cm, 75cm
1047	→	80cm, 100cm	75cm, 96cm
1149	→	100cm	96cm, 106cm
1200	→	100cm, 116cm	106cm
1449 to 1500	→	116cm, 140cm	135cm

**Scope of supply:** Mounting rails, protective sleeves, fastenings

**Suitable only for ordinary waterproof tube sockets!**

**Not compatible with aquaLUMix lamps!**

## Possible configuration of the holders with LED bars:

There are many different possible combinations. It is important that at least one LED bar forms a connection between the two mounting rails. The distance between the mounting rails varies according to the tube length and the LED bar.

### Examples:



## T5/T8 brackets Mounting instructions / Function

The rails of the brackets are attached directly to the back of the LED bar using the screws provided. The screws are screwed into the central groove of the LED bar. The bars are pulled out beyond the end of the LED bar and positioned until the total length of the former fluorescent tube (without contact pins) is reached. (For 361 and 438mm tube lengths, the bars are mounted overlapping). Do not tighten the screws yet. Put the blue protective sleeves supplied onto the two ends of the bars. These prevent the ingress of moisture and protect the electrical contacts of your tube lighting. After the total length has been correctly adjusted, tighten the screw connections and make sure that the bars are firmly attached to the LED bar.

**The power supply of your tube lighting must now be switched off permanently; the future power supply will be provided by an external LED power supply unit.**

Now remove the fluorescent tube from the sockets and place the prepared LED bar with brackets and protective sleeves into the sockets. Be sure to use the protective screw connections of the damp-proof lampholder as usual. Align the LED bar horizontally. That's it.

**PRO<sup>2</sup> LED bars are only compatible with the "solo" version of the holders! Not compatible with aquaLUMix lamps!**

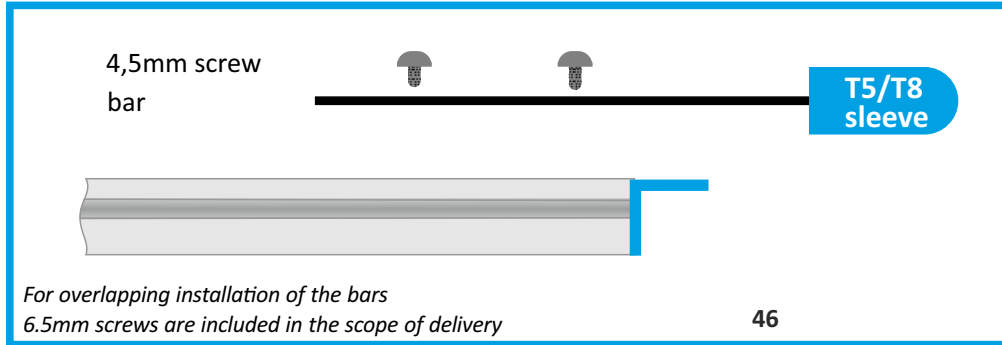
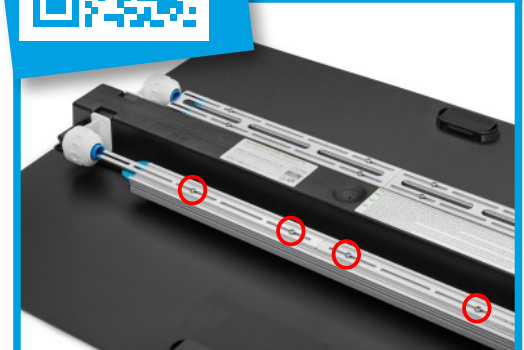

## TRIO mounting

The TRIO holder for e.g. Eheim VivalineLED or Proxima aquariums has an angle on one side which is held in the groove of the aquarium cover. Just like the original lighting of this aquarium. This makes it possible to use any number of holders and LED bars, and to position them as desired.

For up to three eco+ or two PRO<sup>2</sup> LED bars, or one aquaLUMix. Can also be used inside the deLUX and pure aquarium cover.

Also available as XL version: made of 50% thicker material, and especially suitable for the aquaLUMix.

Dimensions: 245x58x2mm, angle height 18mm

## AddON Adapter plate

The AddON adapter plates can be used in a variety of ways. Examples:

- As a fastening and for lateral support of the lighting on existing glass bars, especially with low heights and little space, e.g. with Oase Highline.
- For fastening/extending the aquaLUMix, the AddON plates are screwed to the back and serve as a support. As an adapter for mounting in Aquatlantis profiles.
- For mounting up to 2 additional LED bars when using our T5/T8 brackets or the DUO bracket as the main bracket. \*
- etc.

\* At least one 75cm (or longer) LED bar should be mounted on the main brackets in order to be able to position the addON adapter plate centrally between them. See pictures. The prerequisite is sufficient stability of the existing damp-proof lampholders.

Dimensions: 265x58x2mm

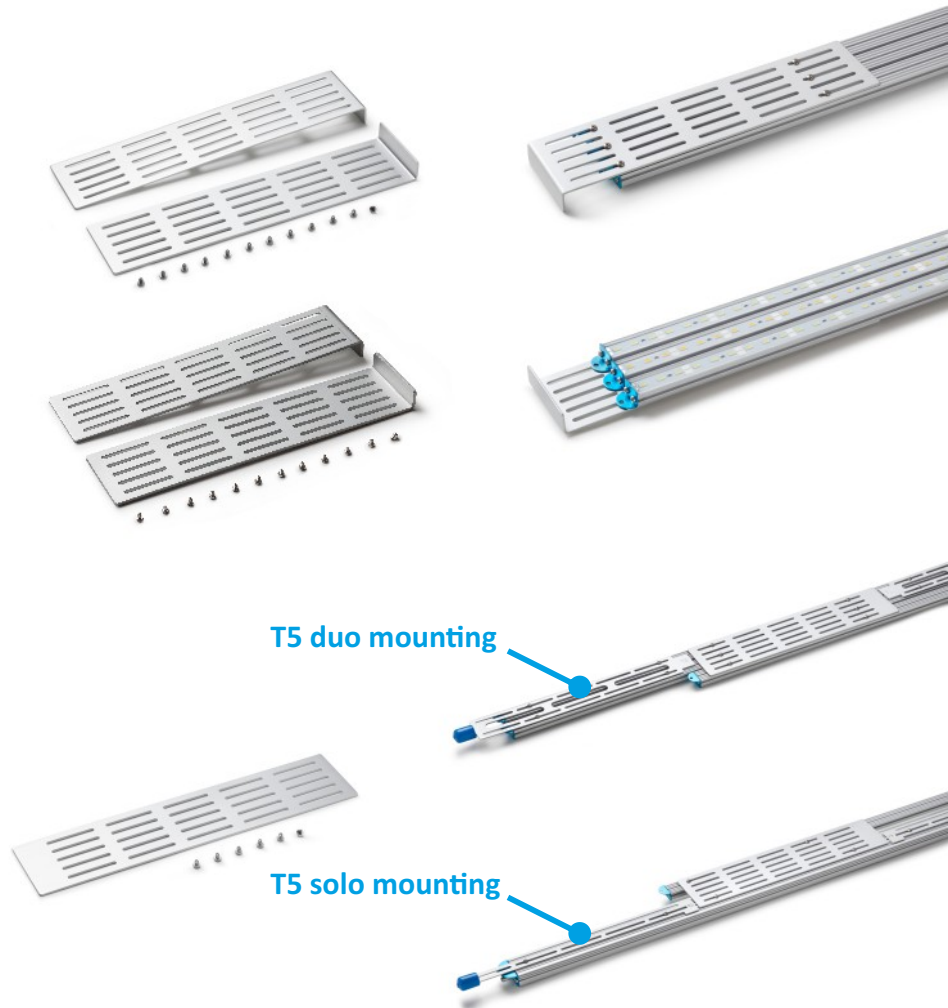



## Flexible mounting solutions

In this way, a wide variety of combinations are possible, e.g. to massively upgrade and convert an aquatlantis / tecatlantis light bar (left) or to equip one of our adapter profiles with lighting well above "standard".

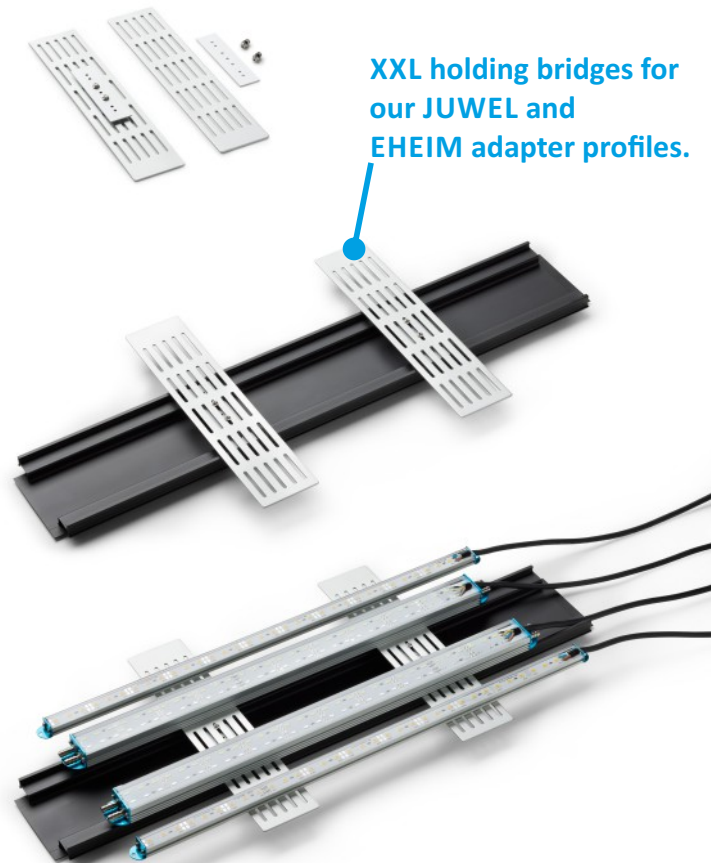
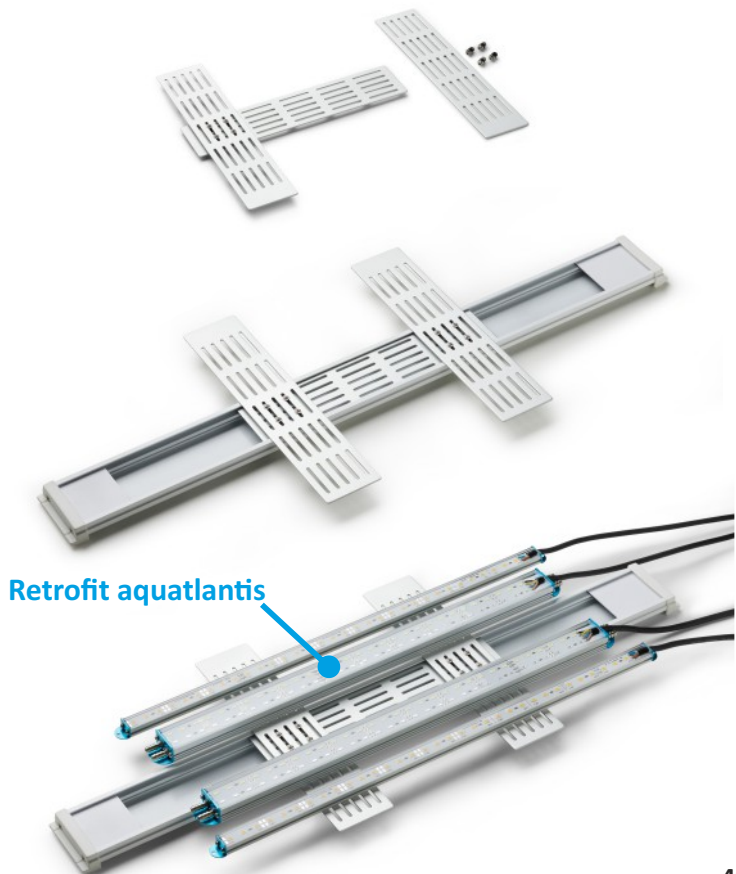

## U-profile as longitudinal or transverse support for LED bars, in custom sizes up to 200cm

For easy and flexible installation of the lighting, even inside a cover.

Advantageous for larger aquariums to span the entire length. And ideally suited for lighting concepts that include several short LED bars or spots.

In combination with a "TRIO holder for U-profile", the U-profile can be hooked in laterally, e.g. within our deLUX and pure aquarium covers. But also in EHEIM Proxima, Incipria and VivalineLED aquariums.

Compatible with the products: eco+, PRO<sup>2</sup>, spotBEAM and aquaLUMix.

VIDEO

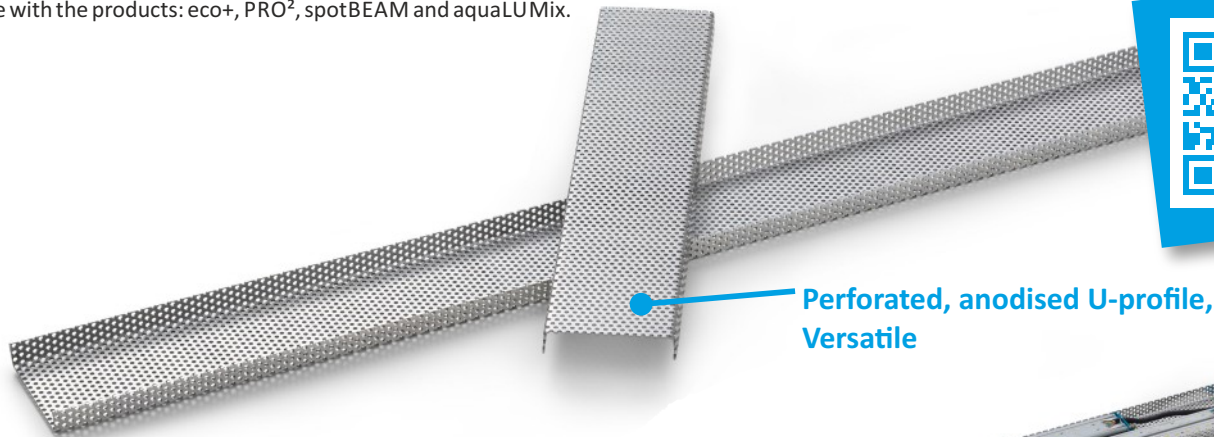

Perforated, anodised U-profile,  
Versatile

### Technical data:

Colour: silver grey

Material: anodised aluminium, 2mm

Length: as desired up to 200cm

Width approx. 104mm

leg height: 20mm

Hole diameter: 3mm (suitable for our 3mm or 2.9mm screws)

### Scope of delivery:

1 piece U-profile made to measure, without further fixing material.

When used within our aquarium cover, a length of length of the aquarium minus 9cm. Plus the TRIO holder

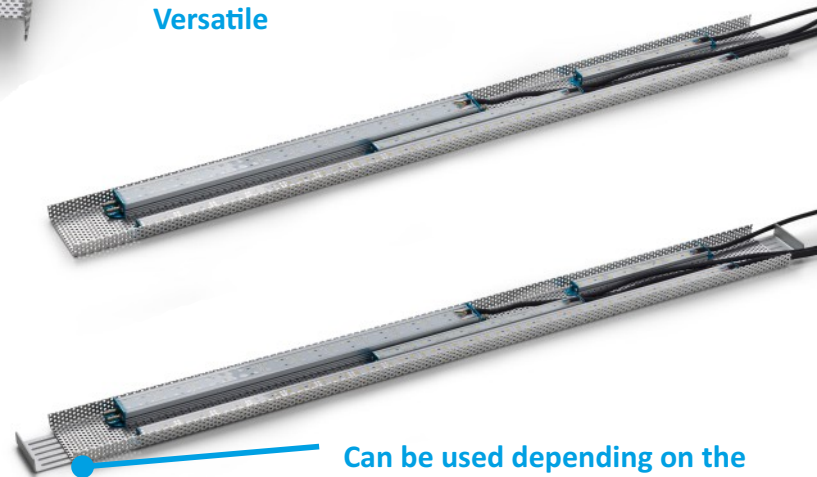

Can be used depending on the  
situation with or without TRIO holder for  
can be used depending on the situation.

## E-profile as guide rail for cover panes, on request up to 300cm in size

Thanks to these guide rails made of high-quality and solid plastic, cover panels can be easily and conveniently slid onto the aquarium. This makes feeding, water changes and any other aquarium maintenance much easier. The guide rails are suitable for 4mm panes and are ideally placed on the longitudinal struts of your aquarium. Fixing by gluing is not absolutely necessary. Length adjustment is possible with a simple hand saw. Please note that you need 2 guide rails per cover!

Colour optionally grey or white

Material: plastic

For panel thickness up to 4mm

Suitable for all cover panes such as

Glass, acrylic glass (Plexiglas), polycarbonate (Makrolon)

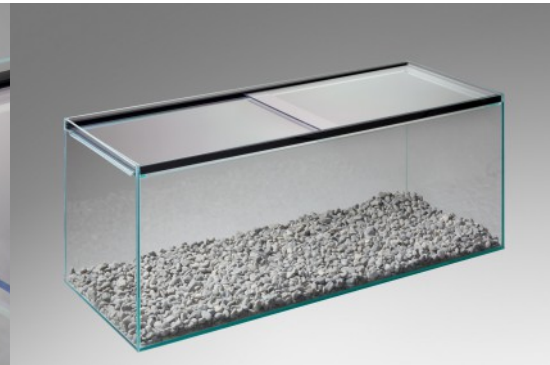
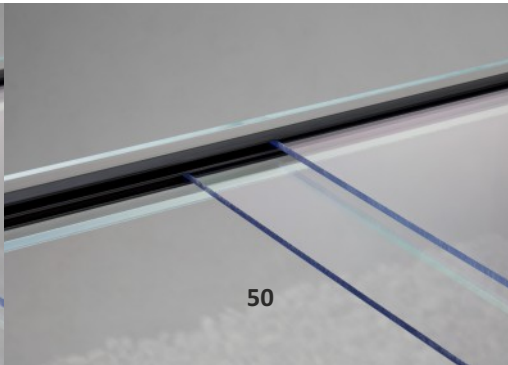
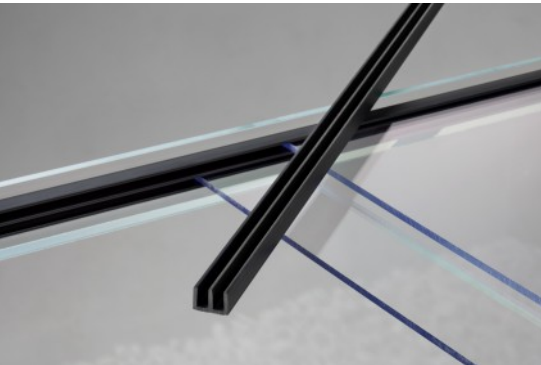

# Exclusivity Above Water: deLUX & Vario Aquarium Covers

Discover the perfect solution for your underwater paradise with our premium aquarium covers. Choose between the **deLUX version**, entirely made of aluminum, with anodized or powder-coated frame and carrier profiles in titanium gray or white and matte brushed surfaces, or the **Vario version**, which impresses with a high-quality plastic frame with a high-gloss finish in white, gray mottled, or black. Note that with deLUX, custom sizes are not possible and only standard sizes are offered, while Vario allows for millimeter-precise adjustments and can be complemented with a matching gravel blend on request for a stylish look.

Both models, deLUX and Vario, are compatible with our state-of-the-art LED bars and offer practical handling with the **Flap or Slide lid systems**, as well as precise processing for maximum stability. The reflective insides of the cover plates ensure efficient light usage, while the robust frames and connections made of aluminum and the covers made of aluminum composite panels guarantee long-lasting resistance.

## Flap

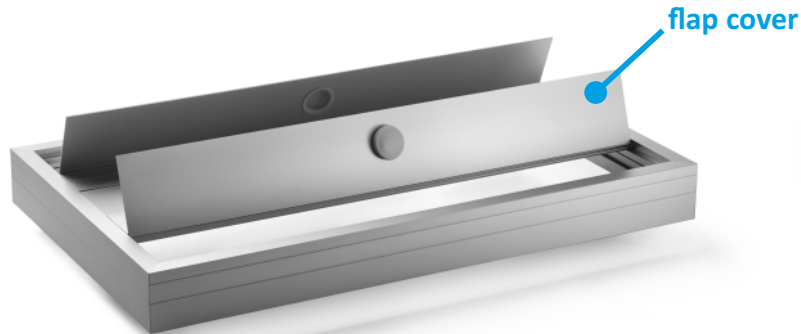

## Slide

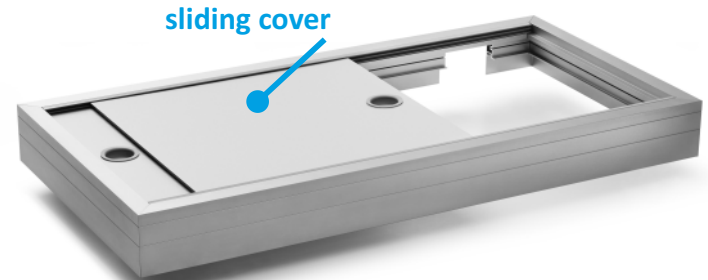

Questions? Perhaps you will find the answer in our FAQ: <http://faq.ledaquaristik.com>

**What are the differences between Flap or Slide covers?**

Flap with folding lid	Slide with sliding lid
With hinged cover system optionally with 1-3 support profiles	With purist sliding lid consisting of 2 elements. Supplied optionally without cover plates for glazing on customer side. (for e.g. pendant lights)
The lighting can be set up in the frame or freely attached to the support profiles.	The lighting is set up in the frame, e.g. with the TRIO bracket for eco+and PRO <sup>2</sup> .
The maximum length of the lighting is tank length -9cm	The maximum length of the lighting is basin length -5cm
The minimum length of the lighting, none.	The minimum length of the lighting when using the TRIO bracket is pool length -30cm.



We will also be happy to help you personally: Mon.-Fri. 8:30-12:00 and 13:00-16:30  
Email: [support@ledaquaristik.de](mailto:support@ledaquaristik.de) | Live-Chat on [www.ledaquaristik.de](http://www.ledaquaristik.de) | Phone: 05257/9366650

## Flip Open and Marvel Stylish Aquarium Covers

The deLUX and Vario aquarium covers with Flap system with foldable lids for easy access, offer elegant design and sophisticated functionality for enhanced aquarium care. The deLUX series is distinguished by its durable aluminum design in titanium gray or white, but is only available in standard sizes. In contrast, the Vario series offers a high-quality plastic frame and the flexibility of custom sizing, complemented by an optional gravel blend for a unified aesthetic.

Both series support our innovative LED lighting, allowing for adaptable use. Suitable for aquarium sizes from 30x30 to 400x150 cm, they feature an XL dirt and water level blend for clear visibility. The reflective inner sides maximize the light from the LED bars, ensuring optimal illumination without light loss. Choose from over 20,000 possible combinations to find your ideal aquarium cover that is not only functional but also visually impressive. Whether it's deLUX in aluminum or Vario with a plastic frame, both options transform your aquarium into a breathtaking underwater world.

### Individual selection options:

#### Cutout for equipment:

- Standard = Cutout on the long side (long side is against the wall)
- Room divider = Cutout on the short side (short side is against the wall)
- Freestanding or internal equipment shaft = without cutout

#### Lid division:

The lid division determines the number of support profiles and depends on the measurement of the short side. The position and distances are always evenly distributed, an exception is possible through the service: Individual lid division.

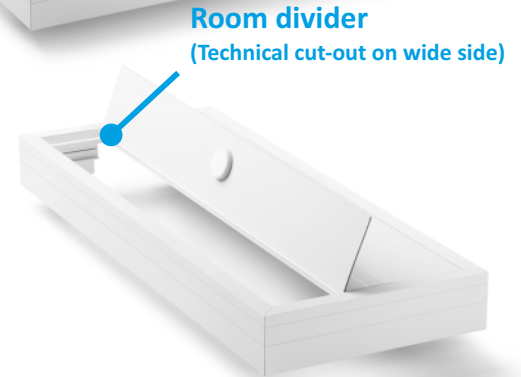
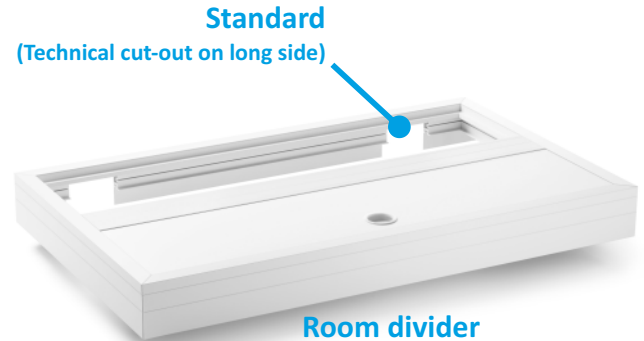

#### Without cut-out



## Flap

The Flap aquarium cover has, depending on the selection, 1 to 3 support profiles for accommodating our LED systems eco+, PRO<sup>2</sup>, spotBEAM, and aquaLUMix. This ensures ideal light distribution depending on the depth and area of the tank. The eco+ and PRO<sup>2</sup> LED bars are attached with the included mounting brackets, while the aquaLUMix and spotBEAM are slid directly into the support profile and secured.

The frame profile also offers a continuous groove as an alternative attachment point. Direct attachment in the frame 90° to the water surface is also possible. For the very special effects of light simulation, e.g., for horizontal shining moonlight above the water surface.



aquaLUMix  
slide-in

Retaining bridges

Direct screw connection

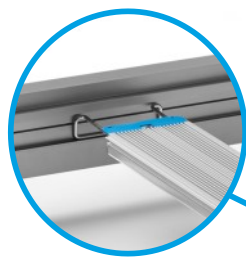

Slot for hanging up / setting up



Mounting in  
Frame (90°)

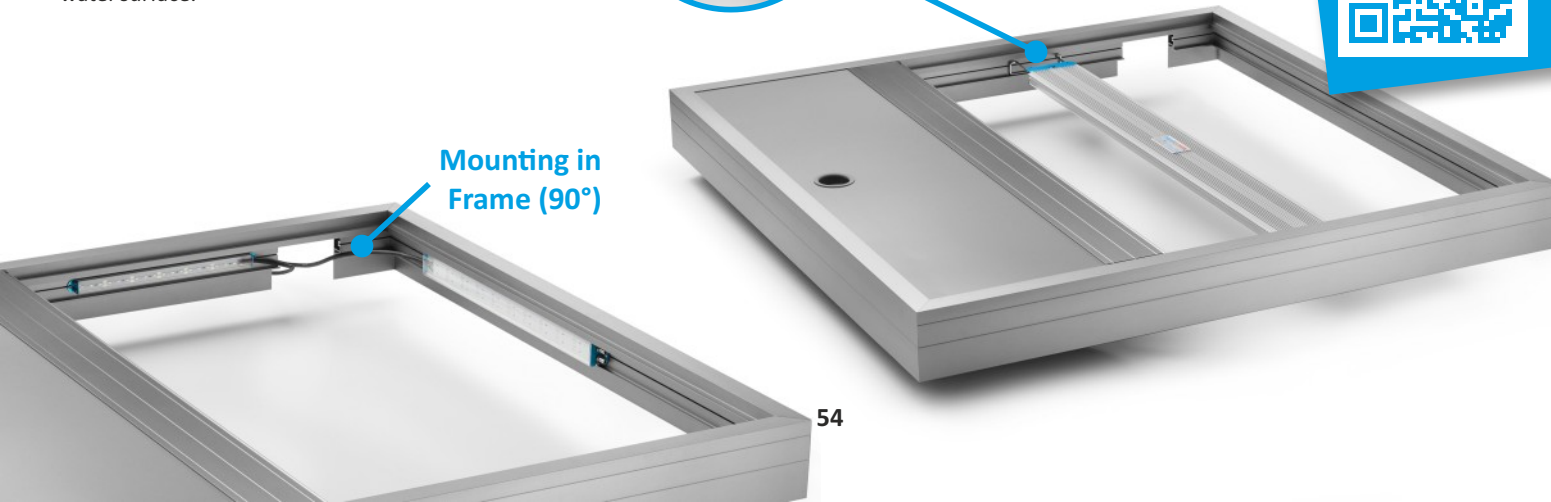

# Flap

The integrated XL dirt and water level baffle (-38mm from the glass top edge) ensures a clean and undisturbed view all around.

The well-thought-out design also allows easy access to the aquarium. The lid flaps can be set up individually or even completely removed with just one hand. The highlight is the insides of the lid panels, which have a mirror-like highly reflective surface that minimizes scattering losses and makes the maximum LED light usable.

## Cross-section and dimensions of the frame profile

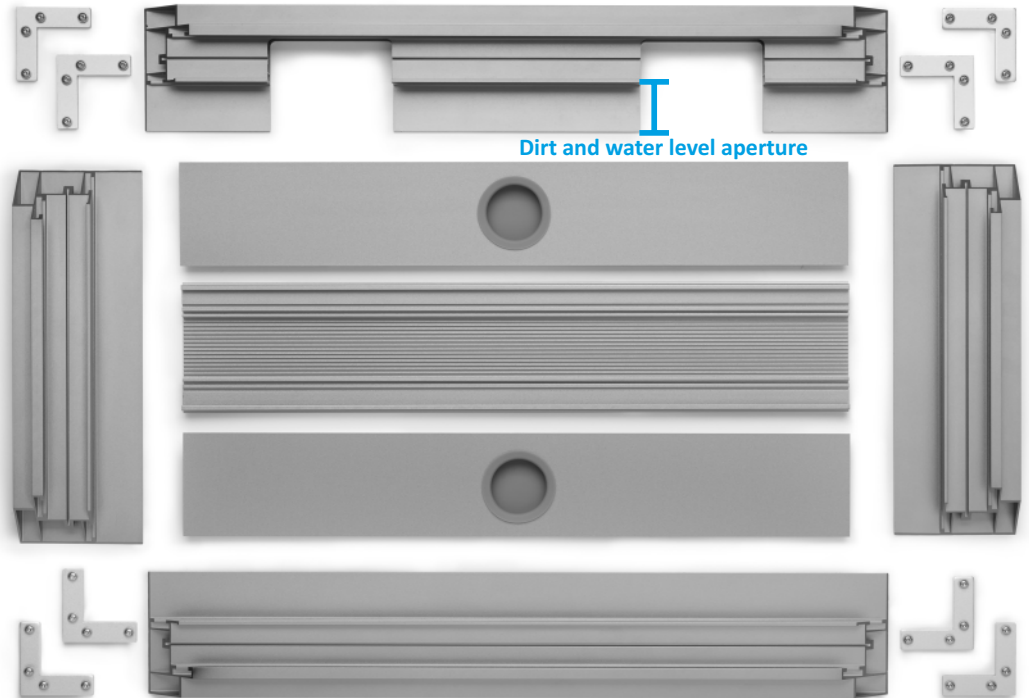
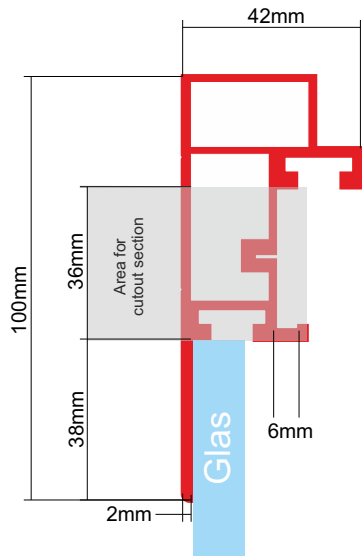



## Flap

### Important to know:

- The glass thickness of the aquarium is not relevant, the cover fits any glass thickness.
- The specified dimensions for length and width always refer to the outer edge to outer edge of the aquarium and do not allow any leeway to exceed these. 1mm clearance is taken into account on each side.
- The support profile (centre beam) always runs parallel to the selected length of the cover.
- The support profile is always planned and supplied by us centrally to the width or, in the case of several support profiles, evenly distributed over the width. This then results in the cover sizes accordingly.
- **The maximum length of an LED light is: edge length of aquarium minus 9 cm (when mounted in the support profile), or minus 5 cm (when mounted/hanging in the frame profile)**
- The lid flaps are produced in two parts from a length of 126cm, in three parts from 246cm, and in four parts from 366cm.
- Size and position of the technical cut-outs: See the respective product description in the online store.
- The Flap aquarium cover is made to order according to the customer's wishes, which is why this article is expressly excluded from the right of withdrawal. If you are unsure about the selection, we recommend our sample case!



### Assembly instructions for flip-top lids

- Provide a soft surface to avoid scratches while mounting your new cover.
- The delivery includes 8 corner connectors and 32 M4x6 Allen screws. These are screwed into the grooves provided in the frame profiles with the enclosed Allen key (2 per corner, see picture on the left). Push the frame profiles completely onto the corner connectors so that there is a right angle. Otherwise there will be unsightly gaps or a cover that is not at a right angle. Before screwing, it is helpful to measure the diagonals from corner to corner. If both measurements are identical, the frame is perfectly aligned! For larger models, we recommend that 2 people assemble the frame.
- Once the frame is assembled, it can be placed on the aquarium. Make sure that the edges of the glass are clean (no sand etc.). If an effect light is to be attached to the side of the frame, it is advisable to do this beforehand. It is not necessary to fix the frame with silicone. If the cover is regularly removed from the aquarium, it would be advisable to protect the edges of the glass with simple adhesive tape to avoid scratching the glass. Cables and hoses are routed through the appropriate technical cut-outs.
- Depending on the size of the order, the support profile(s) is/are now fitted with the LED lighting and inserted into the frame. The scope of delivery includes 2 retaining bridges per support profile up to and including 120cm length, 4 pieces from 121cm length. You will need more than 2 retaining bridges if you want to use more than one LED bar along the length (see p. 67/69). The position within the support profile is free.
- Silicone cubes (11x11mm) are included in the delivery. These are positioned with their self-adhesive underside in the four corners of the frame to allow the lid flaps to close flush.
- The protective foils of the lid flaps must now be removed and the silicone handles inserted. Insert the lid flaps (and any intermediate lids if there is more than one support profile).
- For aquariums with an edge length of 200 cm or more, a height-adjustable nylon support is also included in the delivery for each support profile. This is set up on the glass centre bar of the aquarium and prevents any sagging of the support profile.

## Individual layout for flap lids

As standard, the covers have a symmetrical lid division:

- With one support profile there are 2 cover elements of the same width, the support profile halves the width of the aquarium.
- With two support profiles, there are 3 cover elements of the same width, the support profiles divide the width of the aquarium into thirds.
- With three support profiles, there are 4 cover elements of the same width, the support profiles quarter the width of the aquarium.

Deviating from this, lid elements are possible in size and division according to individual customer requirements.

### What is possible with an individual lid division?

- The support profile(s) can be arranged asymmetrically to concentrate the light in certain areas (front, middle, back). This results in ceiling elements of different sizes.
- Additional narrower lining flaps are possible, see photo.
- Round holes (up to 68mm) for feeders at desired position
- For covers 130cm and longer and multi-part covers, the lengths can be chosen differently.

### What has to be considered or where are the limits?

- The minimum strip width of the covers is 8.5cm.
- The maximum possible dimension per element is 122x122cm.
- The total area of the individual cover elements must be equal to or smaller than the area of the standard cover elements.
- The hinged lid is made in two parts from a length of 130cm and in three parts from a length of 250cm. This cannot be changed even with an individual division.

### What is not possible?

- Adjustments of any kind to the frame profiles.

### How to order the individual lid division?

- Roughly plan your desired division.
- Order the cover, as well as the individual cover partitioning in addition.
- Send us a dimensioned sketch with your wishes by email. You will find a template in the shop. If you need further advice, please contact us by phone.



## Simply Slide Comfortable Aquarium Covers

The deLUX and Vario "Slide" aquarium covers with its puristic and sleek design as well as the child-friendly sliding technology, the pure model sets standards in the aquarium world. The **deLUX series** is distinguished by its durable aluminum design in titanium gray or white, but is only available in standard sizes. In contrast, the **Vario series** offers a high-quality plastic frame and the flexibility of custom sizing, complemented by an optional gravel blend for a unified aesthetic.

Both series support our innovative LED lighting, allowing for adaptable use. The **Slide system, in which lid elements are moved to the side**, is suitable for aquarium sizes from 60x30 to 400x70 cm, they feature an XL dirt and water level blend for clear visibility. The reflective inner sides maximize the light from the LED bars, ensuring optimal illumination without light loss. Choose from over 20,000 possible combinations to find your ideal aquarium cover that is not only functional but also visually impressive. Whether it's deLUX in aluminum or Vario with a plastic frame, both options transform your aquarium into a breathtaking underwater world.

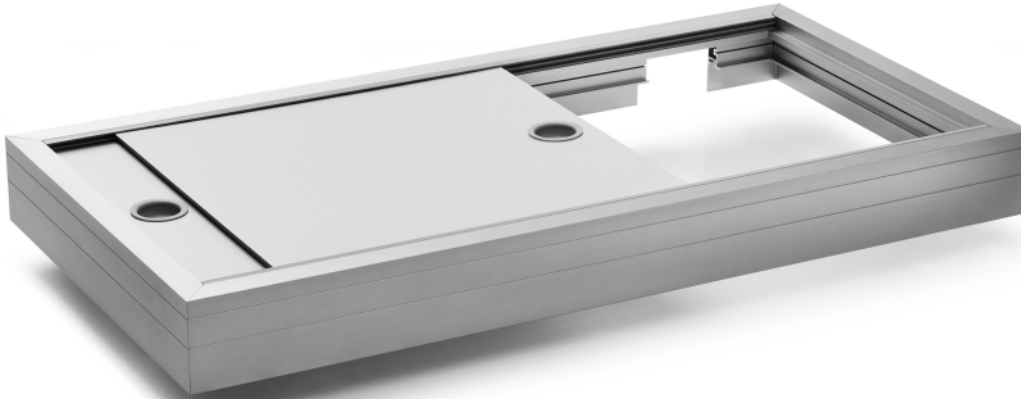

### Individual selection options:

**Technical cutout:** Standard = On the long side (long side is against the wall), Room divider = On the wide side (short side is against the wall) or Free-standing or inner technical shaft = without technical cutout

**Cover plates:** As an alternative to our aluminum composite panels, the cover can also be ordered "for self-glazing" if you want to use, for example, real glass. Suitable glass/panel thickness: 3 mm

## Slide

The Slide Aquarium Cover with sliding lid impresses with quality, functionality, and an impressive price-performance ratio. The frame has a continuous groove as a mounting point for our LED systems eco+, PRO<sup>2</sup>, spotBEAM, and aquaLUMix. The separately available TRIO bracket or the U-profile are the ideal accessories and the perfect complement. This allows the lighting to be positioned freely in the frame and moved as needed. Direct mounting in the frame at 90° to the water surface is also possible. For the very special effects of light simulation, e.g., for a horizontally shining moonlight above the water surface. The two-part sliding lid with grip holes ensures easy handling and maximum accessibility. A sealing lip for the top plate ensures that dripping condensation water is drained off the lower plate. And the special thing: The insides of the cover plates reflect the light, so no beam of light is lost. The integrated XL dirt and water level screen (-38mm to the glass edge) ensures a clean and undisturbed field of vision throughout.

### Quality and Design

Our products stand for top quality. Thanks to precise manufacturing, all components are characterized by minimal gap dimensions and impressive stability. The elegant frame profiles are not only attractive but also easy to maintain and corrosion-resistant. Other components, such as the internal aluminum corner connectors, V4A stainless steel screws, and a lid made of aluminum composite panels, guarantee longevity. Integrated silicone handles in the lid complete the appealing design.



### Groove for hanging/standing

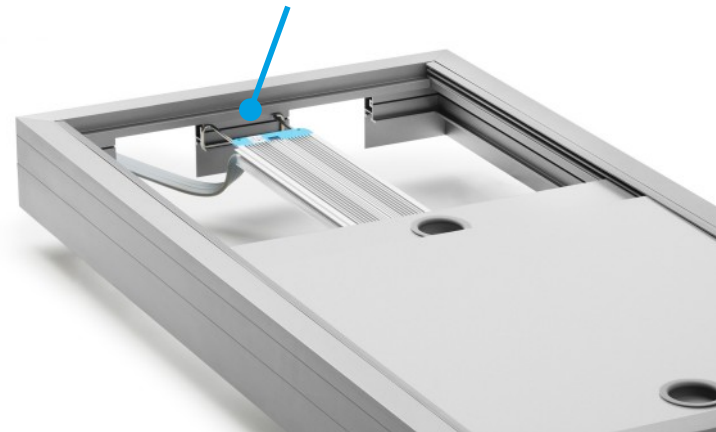

## Assembly instructions for cover with sliding lid

- Provide a soft surface to avoid scratches while mounting your new cover.
- The delivery includes 8 corner connectors and 32 M4x6 Allen screws. These are screwed into the grooves provided in the frame profiles with the enclosed Allen key (2 per corner, see picture p.56). Push the frame profiles completely onto the corner connectors so that there is a right angle. Otherwise there will be unsightly gaps or a cover that is not at a right angle. Before screwing, it is helpful to measure the diagonals from corner to corner. If both measurements are identical, the frame is perfectly aligned! For larger models, we recommend assembly with 2 people.
- Once the frame is assembled, it can be placed on the aquarium. Make sure that the edges of the glass are clean (no sand etc.). If an effect light is to be attached to the side of the frame, it is advisable to do this beforehand. It is not necessary to fix the frame with silicone. If the cover is regularly removed from the aquarium, it would be advisable to protect the edges of the glass with simple adhesive tape to avoid scratching the glass. Cables and hoses are routed through the appropriate technical cut-outs.
- Now that the frame is freely accessible on top of the aquarium, now is the best time to integrate the lighting and other technical equipment.
- The guide bars are inserted into the frame flush with the top edge of the frame on the long side. The bars are not fixed any further so that the lid can be removed completely at any time. They are fixed in place by the cover panels themselves.
- The protective foils of the cover plates can now be removed and the silicone handles can be inserted. When inserting the plates, make sure that the upper cover plate has the sealing lip and that the handle holes are on the outside.



### Important to know:

- The glass thickness of the aquarium is not relevant, the cover fits any glass thickness.
- The specified dimensions for length and width always refer to the outer edge to outer edge of the aquarium and do not allow any leeway to exceed these. 1mm clearance is taken into account on each side.
- **The maximum length of an LED light is: edge length of aquarium minus 5 cm (when mounted/hanging in the frame profile)**
- The minimum length of the lighting when using the TRIO bracket is tank length - 30cm.
- Size and position of the technical cut-outs: See the respective product description in the online store.
- The slide aquarium cover is made to order according to the customer's wishes, which is why this item is expressly excluded from the right of withdrawal. If you are unsure about the selection, we recommend our sample case!

## Vario custom-size aquarium cover up to 400cm

Tailored to your needs: The Vario Aquarium Cover with the Flap or Slide lid systems impresses with quality, functionality, and an impressive price-performance ratio. For aquariums ranging from 30 to 400cm in length, we deliver millimeter-precise covers according to your specifications.

Our cover impresses with its minimalist design and a frame made of high-quality plastic with a glossy surface. The covers made of aluminum composite panels with reflective inner sides maximize the light from the LED bars, ensuring optimal illumination without light loss. Additionally, you can order a matching gravel panel to give your aquarium a uniform and stylish look.

**Available sizes:** From 30x30cm to 400x150cm to the exact millimeter on request



**Available color options:**



**Your desired size - Perfection Made to Order, here's how:**

In the shop, we offer a variety of sizes in 5-10cm increments, covering 90% of the common aquarium sizes. However, if your aquarium has a special dimension, that's no problem. Simply choose the next larger standard length and specify your exact dimension when checking out. For example, for a 97,5cm aquarium, select 100cm and then specify the exact 975mm at the final step at checkout. Our experts take care of details like the safety margin and ensure that your cover fits perfectly!

## Vario - Gravel Panels

To perfect the overall look, we additionally offer a color-coordinated gravel trim. This lends your aquarium a harmonious and appealing look.

Our innovative gravel trim – the perfect border for all rectangular aquariums! Experience a clear, undisturbed aquarium design and focus the view exclusively on what truly matters: your magnificent underwater inhabitants and plants. Depending on the use case, the gravel trim can be used for one to four sides of the aquarium.

### Your advantages at a glance:

- **Aesthetics & Design:** Conceal the lower edge of your aquarium and everything below it. Whether sand, gravel, or unsightly deposits – everything remains out of sight, and your aquarium presents itself in the best light.
- **High-quality Finish:** A simple yet elegant design meets a shiny high-gloss surface. This understated profile perfectly harmonizes with the Vario aquarium covers.
- **Robust Quality:** With a 2mm thick plastic profile, we guarantee you durability. Choose between a height of 50mm or 70mm.
- **Color Variety:** Choose between elegant white, timeless black, and marled gray to perfect your aquarium's appearance.
- **Easy Installation:** Thanks to the self-adhesive back, installation is a breeze. Simply peel, attach, and voilà – your aquarium shines in a new light!
- **Perfect Fit:** Thanks to precise miter cuts, we guarantee utmost precision in fit. And the best part? We custom-make your gravel trim to the exact millimeter of your desired dimension!

Lend your aquarium that special touch and opt for timeless elegance. Our gravel trim not only offers functionality but also a touch of luxury for your underwater palace.



# Light Up in Style: Our Versatile Frame for Every Aquarium!

Experience a new level of individuality and design with our customizable frame. This platform is the perfect setting for your LED bars, allowing you to decide how to utilize it: Whether as a frame-mounted lamp, a floor lamp, or a suspended lamp - the choice is yours.

## Why you should choose this frame:

- Unparalleled Flexibility: It accommodates various LED bar combinations, such as 4x eco+ or combinations with PRO<sup>2</sup> and eco+.
- Compatibility: The frame is compatible with the popular aquaLUMix and spotBEAM models, opening up further personalization options.
- Custom Adjustments: With freely positionable brackets, you can employ LED bars of different lengths, creating your own unique lighting concept.
- Size Options: Available in frame lengths from 25 to 195 cm, it's suitable for both nano aquariums and impressive large aquariums over 200 cm.
- Easy Merging: Should you require a longer or wider frame, you can effortlessly combine two frames using our specialized connectors.
- Optimal Cable Management: The smart side openings and the included spiral tube ensure neat cable organization and a clean look.

Completing the package is the temperature-optimized aluminum frame in a timeless and modern design. It's not just aesthetically pleasing but also functionally crafted to offer the utmost protection and efficient heat dissipation for your LED bars.

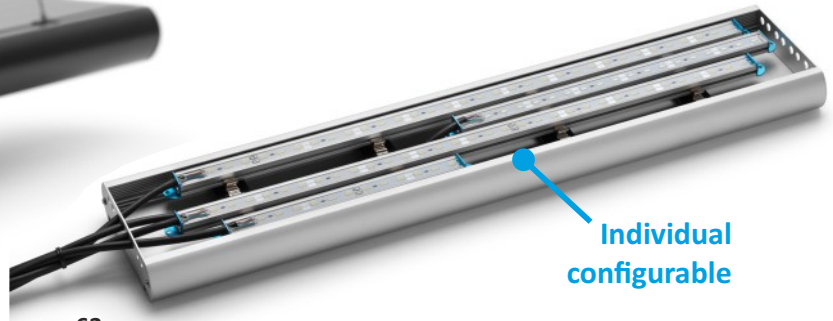
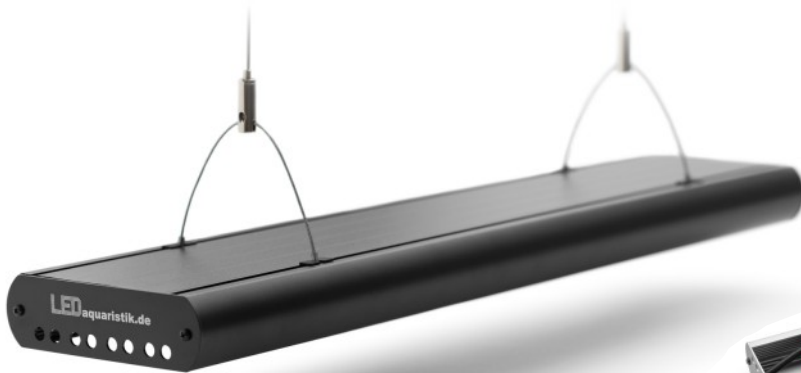



Depending on bracket  
usable as

pendant

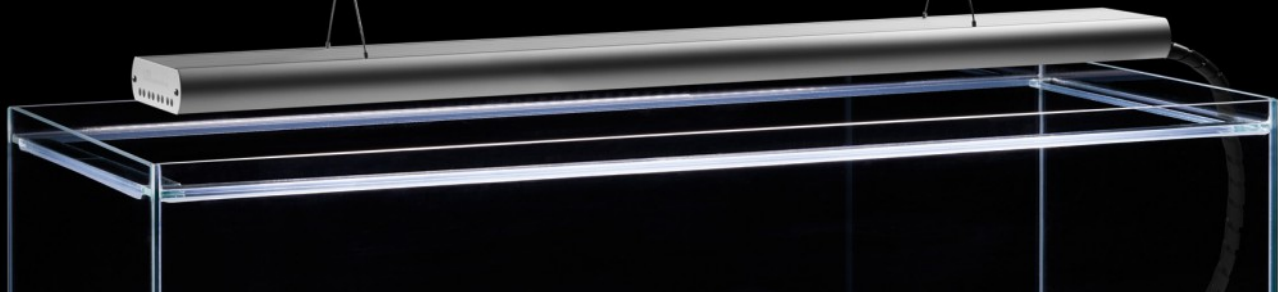

top light



floor lamp

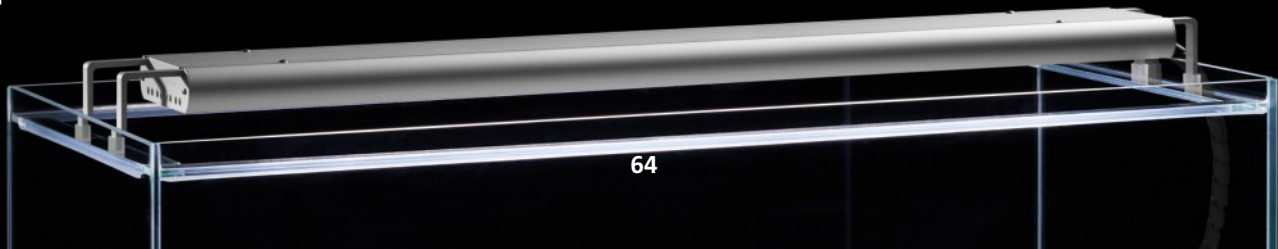

## Lamp housing for LED

Housing lengths from 25 to 195cm, as well as among each other combinable - thus for nano or also large aquariums of over 200cm suitably. With the longitudinal or parallel connectors you simply combine 2 housings firmly with each other and create your desired lighting.

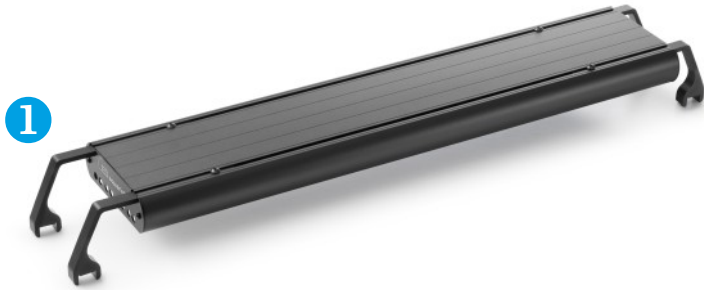

**Side-mounted lamp** = supported on the sides (glass edges) of the aquarium. ①

The correct housing length: The supports increase the overall length of the housing by between +3cm and +20cm

Example: The 105cm housing can be used as a side-mounted lamp for tank lengths of 108cm to 125cm



**Frame-mounted lamp** = supported on the cover plate or glass struts on the aquarium. ② The supports are available in three different heights – which makes them also suitable for use within the cover, e.g. EHEIM Proxima or Incipiria.

The correct housing length: The supports increase the overall length of the housing by between +2.5cm and +22.5cm



**The supports are fastened in the locating grooves in the housing using the supplied hexagon socket screws and are easily adjustable in position.**

*Tip: These products are precision components manufactured to tight tolerances for the highest accuracy of fit and strength. If you find it is difficult to fit the items into the housings, use a little lubricant, e.g. WD-40, liquid hand soap or cooking oil.*



**Suspended lamp** = lamp hanging freely above the aquarium, fastened by steel suspension wires to the ceiling. ③ The suspension wires are attached to the locating grooves in the housing. The distance between the wires is flexible and can be freely chosen. Use the included silicone stops to secure the suspension wires in the locating rooms against unintentional movement. The steel wires can be shortened and adjusted with the quick release clamp.

The ends of the lamp housings are closed with the included end panels. The LED bar connection cables are fed from outside through openings in the end panels ④ and bundled together for neatness to form a cable harness using the accompanying spiral hose. When using the cable extension and connectors, feed the cables through the openings before connecting them together.

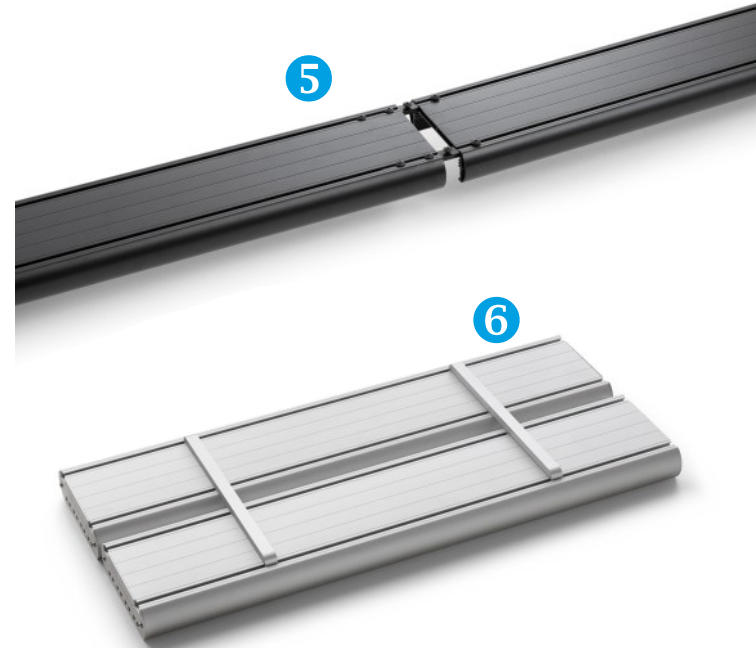

**Longitudinal connectors** Housings can be connected together to make longer ones suitable for use with unusually dimensioned or large aquariums. When longitudinal connectors are used, the lamp housings are not fitted with end panels at the connection points. ⑤ Place the cables over the retaining clip bridges if you wish to have all the cables on one side of the lamp.

**Parallel connectors** Where extremely high amounts of light are required or the aquarium is particularly deep, two or more lamp housings may be connected parallel to one another. ⑥

# Retaining bridges for aquarium cover, lamp housing & LED adapter profile

Retaining bridges for fixing the eco+/PRO<sup>2</sup> LED bars in the aquarium cover with central bar, the lamp housing and in the LED adapter profile for JUWEL and EHEIM aquariums.

Please note that retaining bridges are already included in the standard scope of delivery of the various fixing solutions: 2 pieces up to and including 125cm length, 4 pieces from 126cm length. You need more than 2 pieces of holding bridges if you want to use more than one LED bar along the length (see page on the right). The position within the lamp housing can be freely selected!

## Installation (aquaLUMix Lampen werden direkt und ohne Haltebrücken eingesetzt!)

1. Place the lamp housing with the opening facing upwards on a soft surface (e.g. packing material). If several lamp housings are used, connect them now.
2. now place the LED bars (LEDs pointing towards the floor) next to the housing and arrange them as desired, taking into account the total length of the components. (Any hose connections between the PRO<sup>2</sup>s must now be made).
3. Now position the retaining bridges and screw them in place with the enclosed screws. To ensure that the eco+ and PRO<sup>2</sup> LED bars are at the same height/level, the eco+ is fastened with the longer (9.5mm) screws and spacers, the PRO<sup>2</sup> with the short 4.5mm screws. The screws are screwed into the central groove of the LED bar. If only PRO<sup>2</sup> or only eco+ LED bars are installed, only the 4.5mm screws are to be used.
4. All LED bars are inserted into the housing or profile together when connected.

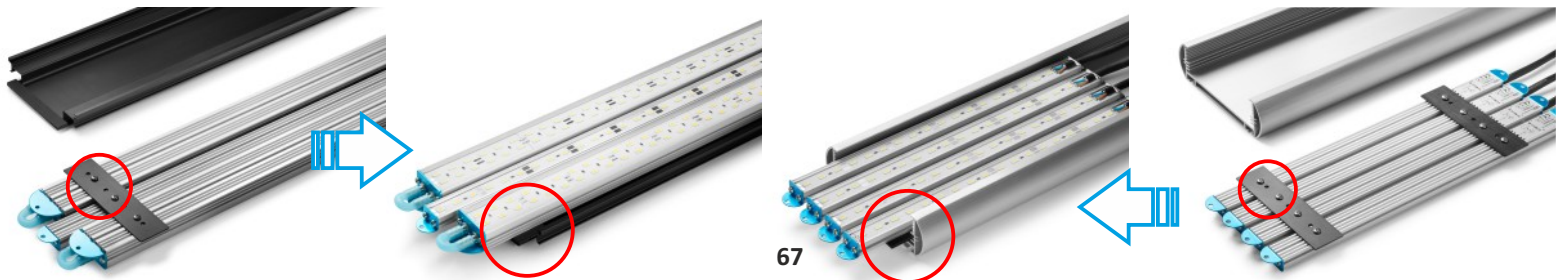
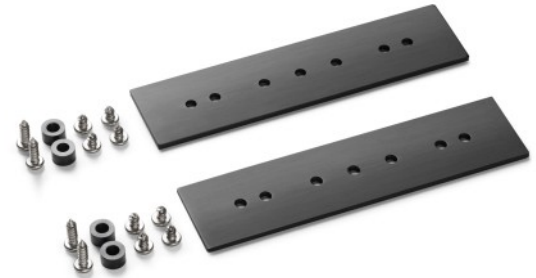

# Example of a possible configuration of our lamp housing and LED adapter profiles for JUWEL, EHEIM & Co.

Example based on a 125cm lamp housing or the JUWEL adapter JU1192

1

4x 116cm LED bars, (2 No. retaining clip bridges required).

2

2x 116cm, 4x 50cm LED bars, (4 No. retaining clip bridges required).

3

1x 116cm, 1x 80cm, 2x 50cm, 3x 30cm, 1x 20cm LED bars, (6 No. retaining clip bridges required).

The scope of supply of the housing and adapter includes 2 No. retaining clip bridges for lengths <125cm, >125cm 4 No. retaining clip bridges. Any additionally required retaining clip bridges must be ordered separately

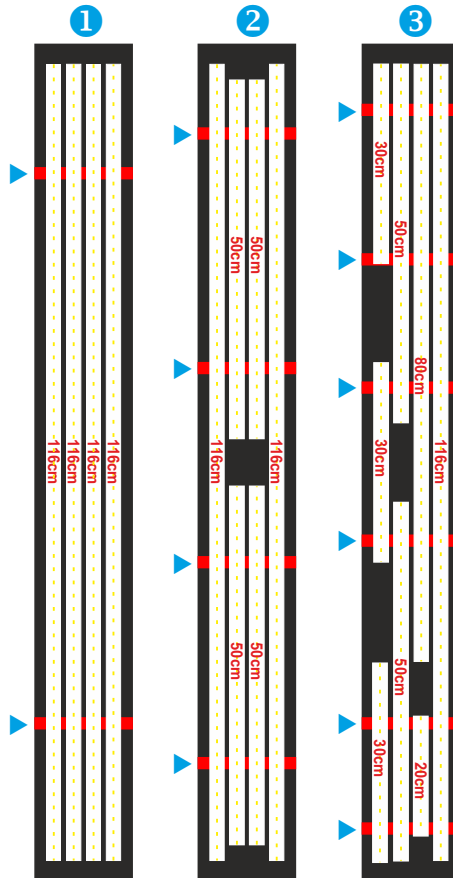

68



Example of the maximum parallel configuration of the lamp housing and LED adapter profiles

4x eco+



1x PRO<sup>2</sup> and 2x eco+



2x PRO<sup>2</sup> and 1x eco+



**LED retrofit kits for  
JUWEL and EHEIM  
aquariums**



## LED-Adapterprofile für JUWEL, EHEIM & Co.

**Our LED adapter profile allows you to upgrade your JUWEL or EHEIM aquarium very quickly to a modern LED lighting system.**

The LED adapter profile replaces your existing conventional T5 or T8 batten fittings 1 for 1. The existing cover plates are retained and used in conjunction with the new LED adapter profile.

It offers room for a maximum of 1x aquaLUMix OR 4x eco+ OR 1x PRO<sup>2</sup> and 2x eco+ OR 2x PRO<sup>2</sup> and 1x eco+ LED lighting bars placed in parallel next to one another (see below!). The LED adapter profile offers great flexibility of use and is individually configurable with combinations of different lengths of our LED lighting bars because the retaining clip bridges for the LED lighting bars are freely positionable!

The adapter profile is made of high-quality aluminium and manufactured specially for various models of JUWEL and EHEIM aquariums. Best quality. In contrast to other adapter profiles available on the market, the LEDaquaristik product has no exposed, unfinished saw cuts or machined edges!

**Installation see page 67/68.**

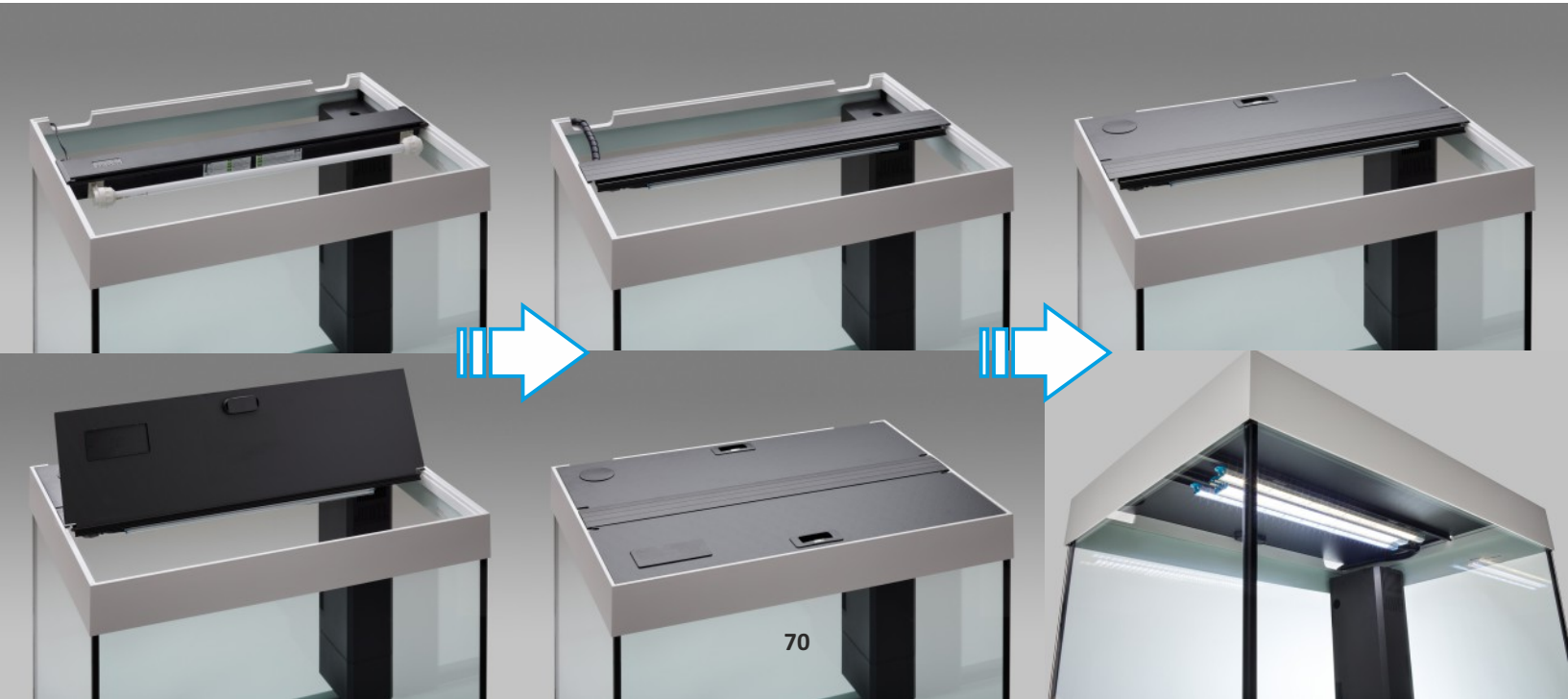

## LED adapter profiles: Models and compatibility

Model	Profile length	Tank length	Compatible with	Max. length LED		
				eco+	PRO <sup>2</sup>	aquaLUMix
<b>JUWEL</b>						
JU0536 / JU0543	536mm / 543mm	-/-	Trigon 350 (back)	50cm*	47cm*	34cm
JU0593	593mm	61cm	Lido 120	50cm*	47cm*	54cm
JU0693	693mm	71cm	Trigon 190 Lido 200	50cm*	67cm*	54cm
JU0793	793mm	81cm	Rio 125	50cm*	75cm*	74cm
JU0903	903mm	92cm	Vision 180	80cm*	75cm*	89cm
JU0993	993mm	101cm	Trigon 350 (front) Rio 180	80cm*	96cm*	89cm
JU1192	1192mm	121cm	Rio 240 Vision 260 Rio 350 (1x), 300 (2x)	116cm*	106cm*	115cm
JU1492	1492mm	151cm	Rio 450 (1x), 400 (2x) Vision 450 (2x)	140cm*	135cm*	144cm
<b>EHEIM</b> for an <i>Incpiria</i> choose the lamp housing as floor lamp, for <i>vivalineLED</i> and <i>Proxima</i> the TRIO holders!						
EH0493	493mm	50cm	scubacube 125	30cm*	-/-	34cm
EH0543	543mm	55cm	scubacube 165 marine	50cm*	47cm*	34cm
EH0643	643mm	65cm	scubacube 270	50cm*	47cm*	54cm
EH0771	771mm	-/-	scubacorner 200	50cm*	67cm*	54cm
EH0793	793mm	80cm	scubaline 140 vivaline 126	50cm*	75cm*	74cm
EH0993	993mm	100cm	scubaline 200 vivaline 180	80cm*	96cm*	89cm
EH1193	1193mm	120cm	scubaline 240 vivaline 240	116cm*	106cm*	115cm
EH1293	1293mm	130cm	scubaline 460	116cm*	106cm*	115cm
EH1493	1493mm	150cm	vivaline 330	140cm*	135cm*	144cm
EH1793	1793mm	180cm	scubaline 640	140cm*	135cm*	144cm

Also suitable for aquariums with a similar lid construction from other manufacturers. In every case, please check your tank dimensions and the length of the lamp battens before ordering.

\*Or a combination of various shorter lengths of LED lighting bars.  
See page 67/68





## Cover for JUWEL and EHEIM aquariums (cover flaps incl. middle bar)

For replacing the existing light bars and cover flaps of JUWEL and EHEIM aquariums.

The frame of the existing cover is still used.

Our light profile is used to hold the cover flaps and lighting. Depending on the selection, 1 piece (2-part cover) or 2 pieces (3-part cover). A light profile offers space for a maximum of 1x aquaLUMix OR 4x eco+ OR 1x PRO<sup>2</sup> and 2x eco+ OR 2x PRO<sup>2</sup> and 1x eco+ LED bars in parallel next to each other (see below!). In addition, the light profile is flexible and can be individually equipped with combinations of different lengths of our LED bars, as the retaining bridges for the LED bars can be freely positioned! The light profile is made of high-quality aluminium, anodised in black, accurately fitting and specially manufactured for the various aquarium models from JUWEL and EHEIM.

The lid flaps are made of aluminium composite panels and stand for durability at the highest quality level. Beautifully shaped silicone handles integrated into the lid complete the overall package. If required, the lid flaps can be opened very easily, set up vertically or removed completely.

The highlight is the inside of the lid panels, which have a mirror-like, highly reflective surface to minimise scattering losses and make the maximum use of LED light. The hinged lid is produced in two parts from a length of 120 cm.

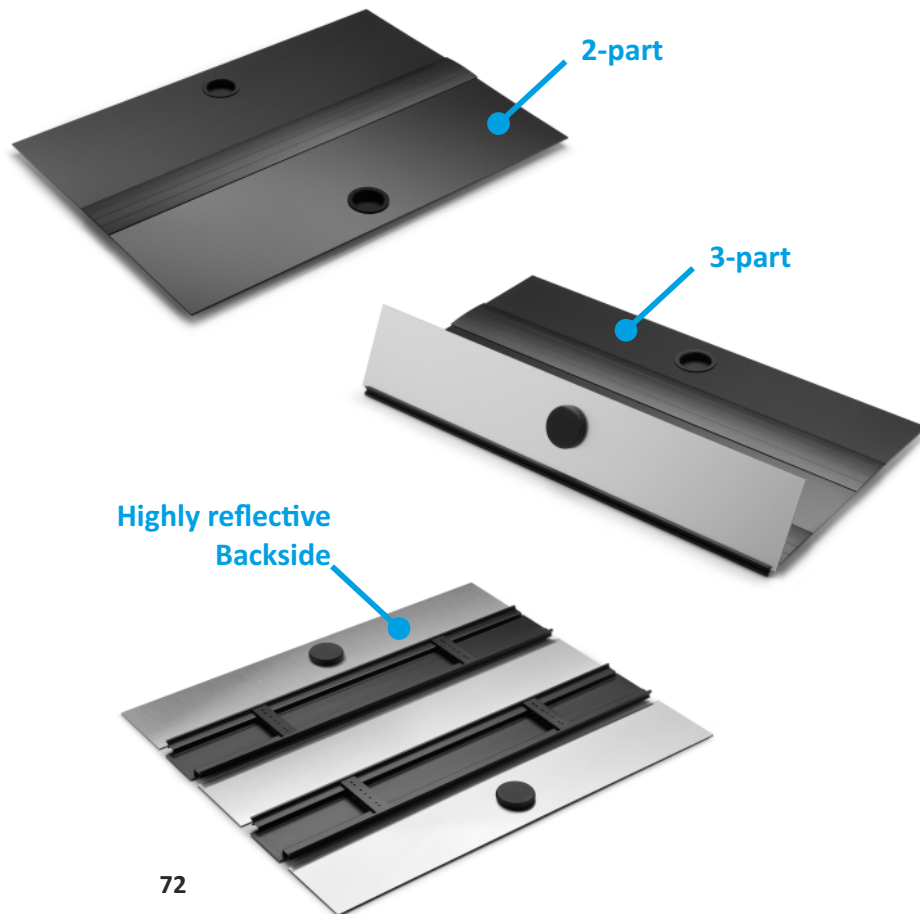

# Automatic light control & Daylight simulation



## **An automatic light control system offers great advantages for you and your animal!**

Aquarium lights switching on and off suddenly is a source of recurring shock and stress to which your animals are exposed on a daily basis. The inhabitants would be much less nervous if they were gently brought out of their night-time rest. Moreover, a gradual, dimmed sunrise and sunset is not only closer to nature and visually very appealing, it also ensures that you are not suddenly plunged into darkness yourself at some point in the evening.

**Our automatic light controls have between 2 and 8 singly and individually programmable channels, depending on the model. This allows each connected LED lamp to be controlled separately in terms of time and brightness. Therefore, in addition to simply modelling the sun rising and setting, you can add details such as stormy weather, clouds, moonshine and many other programs and simulations. See page 82**

**Another big advantage:** During daylight simulation, it is only very seldom that all your LED bars are operating simultaneously at full power, which has positive consequences for the electricity they consume. With only a slight throttling of the output (dimming), the power consumption drops almost in direct proportion without the light appearing noticeably less bright. A secondary effect is an extension of the service life of the LED lamp.

# SimuLUX 24

Your tool for individual daylight simulation. Create a harmonious and natural lighting experience with the SimuLUX 24 daylight simulator. With 5 individually programmable channels, this mid-range model offers flexible options for every requirement. In direct comparison with its predecessor, the SIMU-LUX (blue device), the new SimuLUX 24 has some impressive new features:

- Up to 48 steps programmable per 24-hour cycle
- Modern USB-C interface
- Protective cover for terminal connectors
- Compact dimensions, only 7x11cm in size

Simple programming and updates are made possible via a USB connection with a Windows PC. Design a 24-hour cycle entirely according to your wishes. From dawn to moonlight, you can simulate:

- Dawn
- Sunrise
- Static darkening periods (e.g., cloudiness)
- Noon sun
- Dusk
- Sunset
- Moonlight



*The device contains a replaceable CR1220 lithium button cell battery*

Save multiple daily routines and start them conveniently at the push of a button directly on the device. We also offer sample programs for an optimal and convenient start. With the free SimuLUX software (for Microsoft Windows), you can also program the device yourself in no time.

For further information, see [www.ledaquaristik.de/en/SimuLUX](http://www.ledaquaristik.de/en/SimuLUX)

Software download see back of unit.

For operating instructions, see separate booklet.



The device must not be placed on or inside the placed on or inside the aquarium cover!

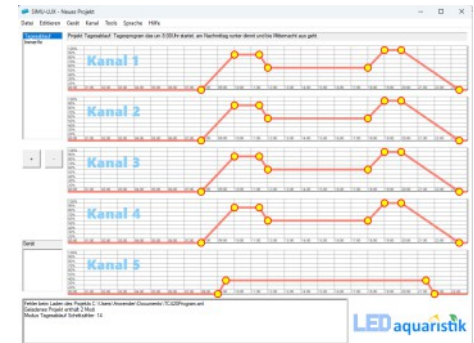

NEW: Alternative software with graphical interface

# SunRiser 2XL

Small, Simple, Functional.



## ✓ SunRiser algorithm

The dimming function is based on a unique algorithm that produces an absolutely gentle and smooth dimming curve - unique to all our SunRiser light control systems!

## ✓ SmartControl

The LEDs are never controlled at maximum voltage, thus ensuring an optimum service life.

## ✓ Maintenance function

A simple press of a button sets the brightness to 0%, 100% or back to the programmed setting for any time you wish to work on the aquarium/terrarium.

## Description

### Characteristics:

- Simplicity itself to program without a PC etc. The settings are made directly on the device.
- **2** separate and individually programmable channels
- Compatible with all our LED bars
- **SmartControl** - for the optimum service life of your LEDs
- **SunRiser algorithm** - for an absolutely gentle and smooth dimming curve

### Functions / settings:

- Time for switching on/off
- Sunrise/-set, moonrise/-set
- Dimming phase duration freely selectable
- Maximum brightness freely selectable
- Maintenance function

### Technical data SunRiser 2+

- Suitable for maximum 60W (5A/12V) output per channel  
Total output channels 1+2 maximum 120W (10A/12V).  
**A double use per channel is possible under consideration of the maximum connected load in total and per channel. Not compatible with an LED splitter.**
- Dimensions LxWxH: 120x70x25mm

### Technical data SunRiser XL

- Suitable for maximum 120W (10A/12V) output per channel  
Total output channels 1+2 maximum 240W (20A/12V).  
**A multi use per channel is possible under consideration of the maximum connected load by using the LED splitter.**
- Dimensions LxWxH: 150x70x25mm



The device must not be placed on or inside the placed on or inside the aquarium cover!

## Setting

**1. The current time needs to be set when switching the SunRiser 2+ on for the first time:** First set the hour value using the ▲▼ buttons and confirm with **OK**. Then set the minute value in the same way using the ▲▼ buttons and confirm with **OK**.

**2. Set the switching times, dimming duration and maximum brightness for the connected LEDs (at LED#1 and LED#2):**

Start Setup by pressing ▲ or ▼.

Select LED#1 using the ▲▼ buttons and confirm with **OK**.

- **AN/ON LED1 is the switch-on time** for LED#1, set with ▲▼ and confirm with **OK**.
- **Aus/Off LED1 is the switch-off time** for LED#1, set with ▲▼ and confirm with **OK**.
- **Dimzeit1/Dimtime1 is the dimming duration** in minutes for the sunrise and sunset. The maximum peak value resulting from the ON and OFF times is displayed on the right. Set using ▲▼q and confirm with **OK**.
- **Max LED1 is the maximum brightness value** (10-100%), set with ▲▼ and confirm with **OK**. And that's it done. The simulation for LED#1 is now running.

**3. To make the settings for channel LED#2, start Setup again and set the appropriate values for LED#2, see 2.**

**4. The maintenance function, button ✂**

1. Press: all LEDs are switched off 0%
2. Press: all LEDs are switched on 100%
3. Press: the simulation continues.

**5. To return the device to the factory settings,** press button ✂ for approximately 5 seconds.

**Example of a full range of settings:**

Channel 1: Sunrise and sunset, e.g. SUNSET  
Channel 2: Main lighting, e.g. TROPIC or DAY  
or

Channel 1: Main lighting with sunset  
Channel 2: Moonlight: e.g. with ROYAL BLUE

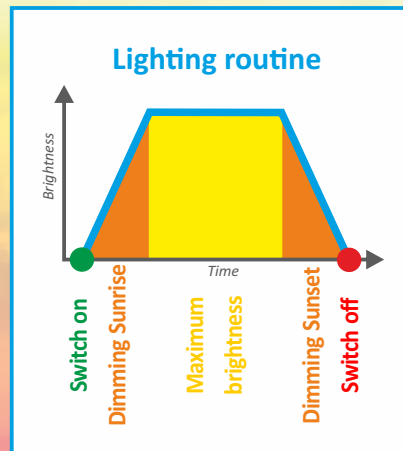

# SunRiser 6

VIDEO



# SunRiser 6

The smart lighting control,  
simple to operate,  
great in function!

**SPECIAL  
OFFER**

Do you want the lighting control system  
to be ready to go straight away?  
Exactly according to your ideas?  
Then the "Programming service" is  
service is just the thing for you!

See page 107

## Features:

- **Immediate start** possible with pre-installed lighting programmes.
- **Programming without PC etc.**, settings are made directly on the device via multibutton and LED display.
- **Assistance function** for easy and quick programming of a daily schedule.
- Compatible with all our LED bars
- 6 separately and **individually programmable channels**
- Individual lighting programmes can be created and in turn assigned to one or more channels. This guarantees maximum flexibility and functionality.
- **Each day of the week can be programmed separately and individually if required!**
- **SmartControl** - for an optimal life span of the LEDs, they are never controlled with maximum voltage.
- **SunRiser algorithm** - the dimming function is based on a unique algorithm that provides an absolutely smooth and jerk-free dimming curve - unique to all our SunRiser lighting controls!

## Functions:

- Time for switching on/off
- Sunrise and sunset
- Duration of dimming phases
- Light output adjustable 0-100
- Function test per channel
- Change of summer/winter time
- Static dimming periods (cloudy, rainy day, etc.)
- If required, **lunch break** with start time, duration, light output 0-100%
- **Maintenance function:** Temporary full output for work on the aquarium

## Example of a light composition:

Channel 1: Sunrise and sunset, light colour RED or SUNSET.

Channel 2: Main lighting, light colour: TROPIC, DAY, or SKY etc.

Channel 3: Main lighting, light colour: POLAR, REEF or MARINE etc.

Channel 4: Moonlight, light colour: e.g. ROYAL BLUE

Channel 5: Mini pump for water cooling

Channel 6: Reserve for future LED upgrade

# SunRiser 6 Operation / function

SunRiser 6  
LEDaquaristik.de



Use the **Multibutton** to make the settings by the "press and turn" method or page through the menu. .

Monday 11:55  
Programme

Programs 4/26  
Program D 6/24

Program D 6/24  
1/ 6 07:30 0%

Delete? D 07:30  
Yes => No

Hour? D 07:30  
07:30 0%

Minute? D 07:30  
07:30

Brightness 0%  
07:30 0%

Program D  
New point

Hour? Prg.D  
09:00

Minute? Prg.D  
09:00

Brightness Prg.D  
09:00 80%

Program A  
Copy

Copy Program A..  
to Program B

Program A  
Assistant

Assistant A  
SunRise Standard

**Programs** is a sequence of timed events and contains up to 24 program points. Each of these points contains a time (Hours:Minutes) and the associated brightness value in %.

**4 programs A, B, C, D are preprogrammed on the unit as supplied (4/26).**

Program D contains 6 individual program points (6/24). Program point 1/6 gives the brightness value of 0% at 07:30. See left. Thus the light switches on at 07:30 because the following program point 2/6 schedules a brightness value of 80% at 09:00. **(see table right!)**

The device dims (dims or brightens) the light evenly and linearly with respect to time as the program runs from one program point to the next. In this case, the light is brightened from 0% to 80% within 90 minutes (07:30-09:00). The current program can be deleted, amended or added to with new points or a program. **Each of the 26 programs (A-Z) can have a maximum of 24 points!** Save yourself work and **copy a complete program**, which you can then either edit to suit your needs or use unchanged.

## Example of a simple daily lighting routine: :

Time	Output
08:00	0%
10:00	100%
20:00	100%
22:00	0%

### Result:

The light switches on at 08:00  
Sunrise from 08:00 to 10:00  
From 10:00 to 20:00 100% output  
Sunset from 20:00 to 22:00  
The light switches completely off at 22:00

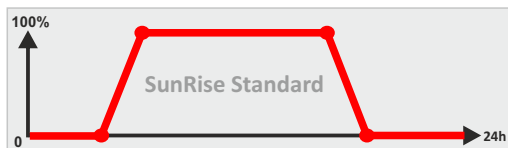

Sunrise A  
Hour: 08

Sundawn A  
Hour: 20

Sunrise/-set A  
In 120 Minuten

Assistant A  
SunRise Effect

Sunrise A  
Hour: 08

Sundawn A  
Hour: 20

Sunrise/-set A  
In 120 minutes

Program A  
Delete?

Delete? Prg. A  
No Yes

The **Assistant function** allows you to quickly and easily create the daily lighting routine. All you have to specify are the times for sunrise (Start or Light on), Sunset (beginning of the dimming phase) and the duration of these phases. All the rest of the **program points are automatically set for you.**

The assistant adds these points to existing programs! The assistant offers two variants: Standard and Effect. "SunRise Effect" is particularly good at allowing effect colours such as morning reds (RED) to be introduced for short periods. "

SunRise Standard" on the other keeps the light of the sunrise (e.g. SUNSET) on at a high value over the whole day. See the graphs on the left! You can also edit the program manually.



Monday 11:55  
Assign LED

**Assign LED.** Every channel or every **LED (#1 to #6)** is assigned a **previously created program**. More than one programme can be assigned: e.g. if you wish to have **different lighting scenarios on different days of the week**.

Programs for...  
LED #4 ABCHHHH

In this example the programs ABCHHHH are assigned to LED #4. The sequence of letters ABCHHHH provides an overview of the week. Monday: A, Tuesday: B, Wednesday: C, the rest of the week (everyday): H

LED #4 ABCHHHH  
Everyday H

If no programme is assigned to a day of the week, then the ordinary day setting applies.

#4 Everyday H  
Program H

Monday 11:55  
Maintenance

Maintenance  
for XXX minutes

The **maintenance function** is suitable for times when you are working on the aquarium, and full lighting output is not necessary. The current light program is suspended manually and the duration set by the user. All 6 LED channels are activated. **LED off.** Using this option, you can switch off the light for a specific period. The light program is suspended for this period and then continued. Suitable, e.g. for introducing new fish etc.

Monday 11:55  
LED off

LED off  
for XXX minutes

Monday 11:55  
Function test

Function test  
LED #3 776

Function test #3  
Power: 1000

A **function test of individual LED channels** can be very helpful. An output value between 0-1000 is entered. If the menu point is quit, the current light programme continues.

Monday 11:55  
Settings

Settings  
Set time

Weekday Thu  
Thursday

**Settings.** An important and crucial point: The **setting of the current time:** day of the week, hours, minutes

Settings  
Maintenance

Maintenance  
Power: 1000

**Maintenance function.** Enter the light output (0-1000) that you wish to be provided during the maintenance function period. As with the function test, the brightness level is not a percentage value but a PWM or output value. Thus a value of 500 is not 50% brightness!

Settings  
Summertime

One hour...  
.. forward

**Summer/winter** daylight-saving time The current time can be put back or forward.

Settings  
Switch-on point

Switch-on point  
LED #1 0

The **switch-on point** only affects powerBEAM / High-Power-Solution! This PWM value is processed as the lowest (1%) setting when the light is switched on. See page 96.

Settings  
Display

Shutdown ..  
in XXX minutes

If the lighting of the **display** malfunctions, the complete display switched off when it is inactive.

Monday 11:55  
Info

**Info.** This displays current information about operating time, brightness and output values as well as the assigned weekly lighting routine for LED #1 to #6. You can also reset the device including the example program by double-clicking in the **factory default settings**.

Pre-installed example program	07:30	08:00	09:00	10:00	20:00	21:00	22:00	22:30	Function
Program A - LED #1	-	0%	-	100%	100%	-	0%	-	Daylight
Program B - LED #2	-	-	0%	100%	100%	0%	-	-	Daylight
Program C - LED #3	5%	0%	-	-	-	-	0%	10%	Moonlight
Program D - LED #4	0%	-	80%	100%	80%	50%	-	0%	Sunrise /sunset



Suitable for maximum 60W (5A/12V) power per channel - total power channel 1-6 maximum 240W (20A/12V) . Double assignment per channel is possible, taking into account the maximum total and maximum connected load in total and per channel. Not compatible with an LED splitter. The device must not be placed on or inside the aquarium cover!

# SunRiser 6 Principle of operation

## 1. Create a program

A program is the time sequence that controls brightness values at the set times. Example using the pre-installed program A, which comprises 4 points:

1/4	08:00	Uhr	0%
2/4	10:00	Uhr	100%
3/4	20:00	Uhr	100%
4/4	22:00	Uhr	0%

◀ The light switches on from 8 o'clock and slowly dims up to 100% within 2 hours. From 10 to 20 o'clock the light shines constantly with 100%. From 8 pm the light dims down again until it reaches 0% at 10 pm and thus switches off.

For example, to add a lunch break, the program is expanded to eight points as follows

1/8	08:00	Uhr	0%
2/8	10:00	Uhr	100%
3/8	11:45	Uhr	100%
4/8	12:00	Uhr	0%
5/8	13:45	Uhr	0%
6/8	14:00	Uhr	100%
7/8	20:00	Uhr	100%
8/8	22:00	Uhr	0%

◀ Now the light is dimmed to 0% within 15 minutes from 11:45 and remains switched off from 12 to 13:45. It then switches on again at 13:45, dims up within 15 minutes and reaches 100% again at 14:00.

**It is important that a program is covered by "0% points", otherwise the light will never switch off completely.**

In the example above the 1/8 point would be missing, the illumination would only be at 0% at exactly 22:00 o'clock, already one second later the brightness increases again until 100% is reached at 10:00 o'clock.

Up to 26 separate programs (A-Z) can be created, each containing up to 24 points. These programs are then assigned to the LEDs and weekdays...

## 2. Assign LED

The SunRiser 6 has 6 connectors on the rear side where up to 6 LEDs can be connected and controlled separately. In the factory setting 4 programs (A, B, C, D) are stored on the device, which are assigned to these channels LED #1 to LED #4. This means that channel LED #1 is assigned program A on all days of the week. LED #2 B, LED #3 C and the channel LED #4 the program D.

On page 60 of the operating instructions, the table shows the individual switching times, assignment, brightness and function of these programs in the daily schedule.

**It is mandatory that a created program is assigned to one (or even several) LEDs, only then the program will be started. As soon as the assignment has been made, the program starts automatically according to the current time.**

**Attention: In the factory state, LED #5 and LED #6 are not yet assigned a programme!**

Assignment of the pre-installed programs (factory setting):

LED #1	LED #2	LED #3	LED #4
AAAAAAA	BBBBBBB	CCCCCCC	DDDDDDD
Monday	Tuesday	Wednesday	Thursday
Friday	Saturday	Sunday	

For special lighting times on LED #1 and LED #2 at the weekend, two new programs E and F are created and assigned as required:

LED #1	LED #2	LED #3	LED #4
AAAAAEE	BBBBBFF	CCCCCCC	DDDDDDD

On LED #1 to 3 the same light settings should run daily, on LED #4 e.g. a moonlight should be operated with its own time/program:

LED #1	LED #2	LED #3	LED #4
AAAAAAA	AAAAAAA	AAAAAAA	CCCCCCC

## Overview: Our lighting controls in comparison



Functions	SunRiser 2+	SunRiser 2XL	SunRiser 6	SunRiser 8	SimuLUX
Max. Brightness freely selectable	X	X	X	X	X
Duration of dimming phase freely selectable	X	X	X	X	X
Sunrise and sunset	X	X	X	X	X
Moonlight possible	X	X	X	X	X
Natural phases of the moon				X	
Interruption or change in the daily routine (e.g. lunch break)			X	X	X
Weekdays individually programmable			X	X	X <sup>2</sup>
Maintenance function (full power for work on the aquarium)	X	X	X	X	
Weather effects static (cloudy, rainy day)			X	X	X
Thunderstorm simulation, lightning				X	
Automatic dynamic effects (e.g. flying clouds, lightning, thunderstorms)				X	
Individually programmable channels	2	2	6	8	5
<b>Characteristics</b>					
Networkable				X	
Programming directly on the device	X	X	X		
Programming with Windows PC				X	X <sup>3</sup>
Programming and control via web browser, all operating systems				X	
Interface, connection possibility				LAN	USB
Automatic clock synchronisation via the Internet				X	
Regular software updates				X	
Software language	EN	EN	EN	DE	EN
Operating instructions	EN	EN	EN	EN	EN
Saving the settings and time in the event of a power interruption	X	X	X	X	X
Open source software = customer extensions possible				X	
<b>Output</b>					
Maximum total power LED 12VDC	120W (10A)	240W (20A)	240W (20A)	240W (20A)	240W (20A)
Maximum power per channel 12VDC	60W (5A)	120W (10A)	60W (5A)	60W (5A)	48W (4A)
<b>Options</b>					
Temperature sensor				X	
External WLAN adapter				X	
Power expandable through High-Power Solution (see page 93)			X	X	

<sup>2</sup>Requires manual switching between programmes. | <sup>3</sup>MAC/OSX with third-party software (Windows emulator) possible.

# SunRiser 8

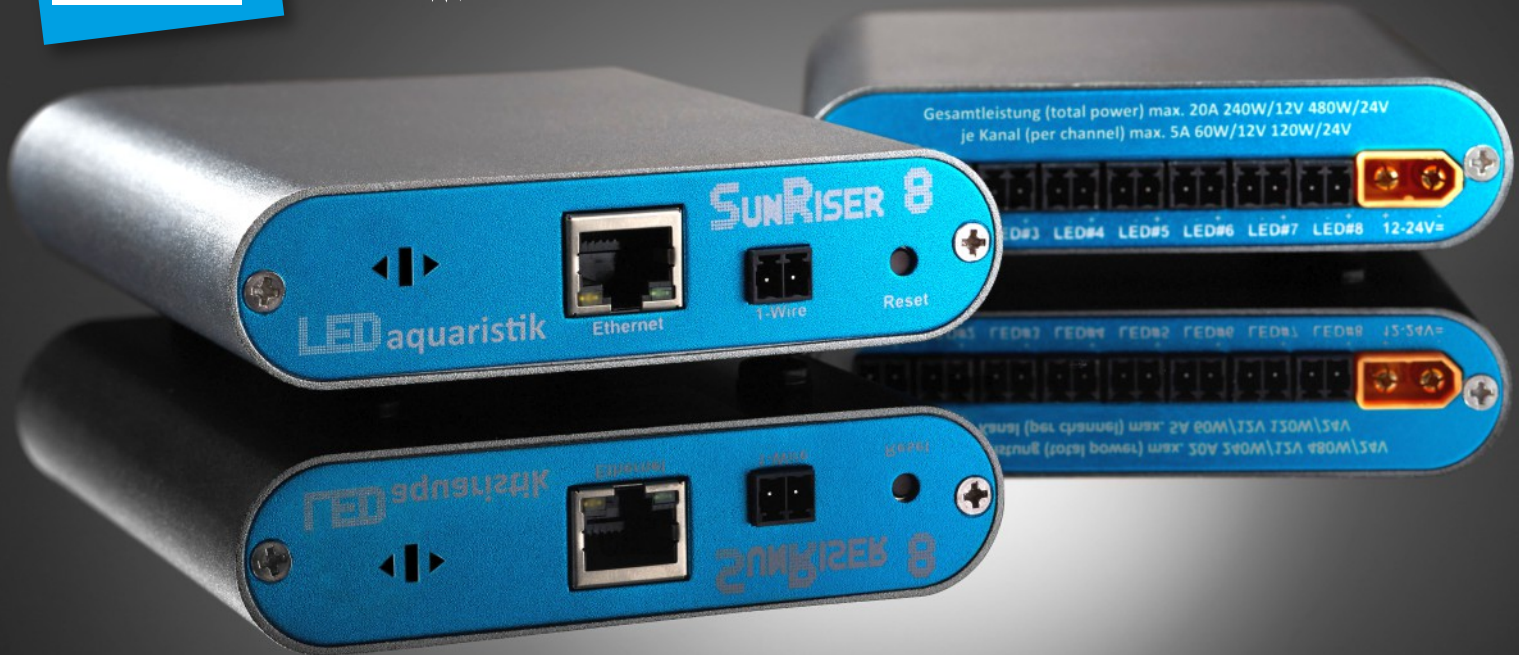

# SunRiser 8

The premium light control for beginners and professionals!  
An in-house development made in Germany!

With the SunRiser 8, you can control your LED aquarium lighting according to your wishes. The device and its intuitive software interface support you with foolproof operation. Let the brightness rise slowly in the morning and create your own sunrise. Switch to intensive midday lighting, or simulate a flight of clouds in the afternoon that temporarily reduces the light. Perhaps a short thunderstorm with flashing lightning effects? In the evening, let the day end with a gentle sunset, and at night, a subtle moonlight glow.

These are just a few of the possibilities available to you. Depending on your needs and the light colours used, the system can be programmed accordingly and expanded at any time. Operation and programming is very simple via your local network and can be carried out using a web browser and end devices such as smartphones, tablets, PCs, notebooks, etc. Programming knowledge is not required! Programming knowledge is not required!

**SPECIAL  
OFFER**

Test it now! <http://srdemo.ledaquaristik.com>

## Features

- Compatible with all our LED bars
- **8 separately and individually programmable channels, each max. 60W (double assignment up to maximum possible)**
- Connection for optional temperature sensor.
- RJ45 connection for integration into the local network.
- Internal microSD for storage of configuration and runtime data.
- Solid aluminium housing with minimal dimensions of only 124x119x26mm.

## Function

- Separately adjustable daily schedules with any number of time windows, per channel.
- Each day of the week can be programmed separately and individually if required!
- **SmartControl** - for an optimal lifetime of the LEDs, they are never controlled with maximum voltage.
- **SunRiser algorithm** - for an absolutely smooth and jerk-free dimming curve
- Configuration and control via modern, pleasant web interface, optimised for all end devices such as tablet, smartphone or PC
- Clear, graphical and intuitive German user interface.
- **Simple creation of day and weather simulation with sunrise, sunset, moon phases, rain, clouds, thunderstorms and lightning!**
- Online help, always up-to-date and in German
- Update via internet (optional, the device does not force you to update).
- Automatic integration into any IPv4 network with DHCP.
- Automatic clock synchronisation via Internet using NTP.
- Open source software, customer extensions possible, continuous further development with customer feedback.

Firmware updates with extensions and improvements appear regularly and free of charge!

# SunRiser 8

Wetter Profil: # Hagelbewölkung

Simuliere Gewitter: AN

Wahrscheinlichkeit eines Gewitters pro maximale Anzahl von Gewittern am Tag: 10

Maximale Anzahl von Gewittern pro Tag: 1

Minimum Länge eines Gewittersturms in Minuten: 10

Maximale zusätzliche Länge eines Gewitters in Minuten: 20

Die Mondphasen erhalten die für Wettersimulation bestimmten LED exakt nach den realen Mondphasen. Bitte seien Sie sich bewusst das dies ggf. im Gegensatz zu ihrer Tagesplanung steht und daher dazu führt das ihre LED erhellt, wo eigentlich abgeschaltet sein sollte.

Wetter Profil: # Hagelbewölkung

Simuliere Mondphasen: ...

Maximale Intensität: ...

Hier stellen Sie die Farben und Funktionen Ihrer LED ein. Vergessen Sie nicht nach der Änderung dieser Einstellungen am Ende der Seite auf 'Speichern' zu klicken.

Für das Verbinden der LEDs zu der Wettersimulation benutzen Sie bitte die [Wetter Profile](#).

Farbe LED #1: RED 12500

LED #1 für Tagesplanung: AN

Farbe LED #2: SUNSET 300K

LED #2 für Tagesplanung: AN

Farbe LED #3: SUNSET 300K

LED #3 für Tagesplanung: AN

Farbe LED #4: DAY 500K

LED #4 für Tagesplanung: AN

Farbe LED #5: DAY 500K

- + LED einstellen
- + Tagesplanung
- + Sicherung
- + Firmware aktualisieren
- + Wartungsarbeiten
- + Funktionstest
- + SunRiser neustarten

Hier können Sie den Tagesverlauf Ihrer LEDs einfach per Klick einstellen. Wählen Sie zuerst oben die einzustellende LED aus, und fügen Sie dann über die Plus Zeichen unten neue Punkte hinzu. Diese können Sie dann im Graphen nach belieben verschieben. Um einen Punkt zu entfernen, drücken Sie einfach auf die Uhrzeit/Prozent Angabe dieses Punktes unten neben den Plus Zeichen. Vergessen Sie nicht nach Ihren Änderungen auch am Ende der Seite auf 'Speichern' zu klicken. Bitte beachten Sie das die Prozentangabe hier eine automatische Gammakorrektur beinhaltet um sich mehr dem menschlichen Empfinden anzupassen.

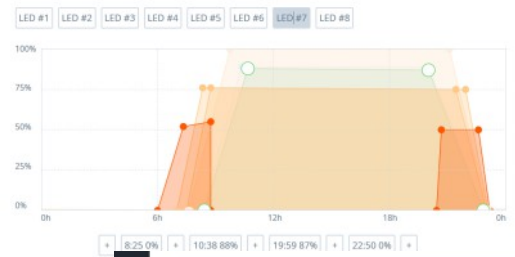

Bitte beachten Sie das wir noch keine Funktion haben um Profile zu entfernen, dies wird sehr bald folgen.

+ Neues Wetter Profil anlegen (Änderungen gehen verloren)

Bezeichnung Wetter Profil #1: Hagelbewölkung

Bezeichnung Wetter Profil #2: Sonne

Bezeichnung Wetter Profil #3: Mond

Wetter Profil für LED #1: ☼ Sonne

Wetter Profil für LED #2: #1 Hagelbewölkung

Wetter Profil für LED #3: #1 Hagelbewölkung

Wetter Profil für LED #4: #1 Hagelbewölkung

Wetter Profil für LED #5: #1 Hagelbewölkung

Wetter Profil für LED #6: #1 Hagelbewölkung

## SunRiser 8 - Start-up



Suitable for maximum 60W (5A/12V) power per channel - total power channel 1-8 maximum 240W (20A/12V) Double assignment per channel is possible taking into account the maximum connected load in total and per channel. Not compatible with an LED splitter. **The device must not be placed on or inside the aquarium cover!**



### Quick start / initial configuration

All configuration of the SunRiser is done via the web interface, where you will also find much more information on how to use your SunRiser. Therefore, this Quick Start only deals with getting you into the Web Interface.

**For the initial configuration, connect the SunRiser to your local router, you can then configure it via PC/MAC, smartphone or tablet.**

You can then use the device with the created configuration without a network connection. An active internet connection is only necessary for firmware updates or future cloud functions. Please make sure to create a backup of the configuration so that you can restore it if necessary. There is a lot more information about backups in the web interface.

### Connecting to the network

Connect the SunRiser to your router using the enclosed network cable. Also connect the LED power supply to the yellow connector of the SunRiser. The LEDs do not need to be connected to be able to configure them! After you have connected the network and power supply, wait a short time and then simply go to the SunRiser Finder website with your computer or mobile device connected to the same network: <http://sunriser.ledaquaristik.de/>.

**Please use an up-to-date browser to set up and configure the SunRiser 8, e.g. FireFox.**

As soon as the SunRiser has received an address in your network, you should see a short information that a SunRiser has been found, but this will redirect you to your SunRiser directly after 10 seconds. If this is not the case, there will be more information on the web page about what you can do to remedy the situation. The best thing to do is to press the reset button on the front of the device and wait at least one minute. Alternatively, you can also (if your browser and router allow the necessary functions) access your device via:

**<http://sunriser/> or <http://sunriser.local/> to access your device.**

**Please note that the SunRiser only reports to the SunRiser Finder server during start-up and therefore requires a functioning Internet connection at that moment so that this function (SunRiser Finder) can be used.**

### Info:

The SunRiser 8 only requires a local network connection for access (setup, programme change).

An internet connection is only necessary for updating the firmware. The actual operation at the aquarium can take place offline.

The operating software and all settings are located locally on the SunRiser 8.

### Data protection notice for the SunRiser Finder

The information that the SunRiser transmits from your network to the SunRiser Finder server is only stored in volatile memory on our server and can only be accessed from the same internet address that supplied it. The function can be turned off via the expert settings under the system settings. The information transferred is the local IP address of the SunRiser, the hardware Mac address and firmware information.

### Web Browser Requirements

The entire web interface and the corresponding cloud functions were designed for modern web browser versions and only work there. Old web browsers on old smartphones that are no longer being updated will not work. **If you have problems with your browser, please update it to the latest version first before contacting us.** We are developing directly on the Chrome browser, so if in doubt, please install exactly this browser, as it is the only one we can best guarantee functionality. Although we have done everything necessary to allow Safari users access to the web interface, there are some older Apple devices that cannot be upgraded to the required Safari version, so please try to install the Chrome browser here, which is also available for Apple devices.

### Renew Firmware

Please check the web interface directly for a new firmware, the function for this can be found behind the cogwheel in the menu or on the start page.

### Factory Reset / Factory Condition

If you do not receive any reaction from your SunRiser after a firmware renewal, or if a last configuration change led to the fact that you cannot reach the SunRiser any more, then you can carry out a so-called factory reset. This will restore the SunRiser to factory settings and move the configuration to an alternative directory, which can then be downloaded using the backup functions. To perform a factory reset, briefly press the "Reset" button in the first 4 seconds after the SunRiser is connected to power and then wait a short time (less than 1 minute) until the factory state is restored.

### Direct connection (without router)

If you need to connect directly to the SunRiser, this is also possible. If the SunRiser is unable to obtain an IP address in the first 2-3 minutes, it will automatically be set to IP address 192.168.0.2. To access this you will need to set your network settings for the connected device to the following values: IP Address: 192.168.0.1 Subnet Netmask: 255.255.255.0.

All other settings such as DNS and Default Gateway are completely irrelevant. After that you can connect to the SunRiser from your device using the following address: <http://192.168.0.2/>.

Please press the reset button if you do not get a direct connection after 10 minutes.



## SunRiser 8 Troubleshooting

If the SunRiser restarts sporadically, does not save settings, activates the LEDs unscheduled or does not load the web interface completely, there may be a defect (write/read error) on the SD card of the SunRiser.

In spite of several function tests by us before shipment, such an error of the microSD card can unfortunately not be avoided completely. Often this problem can be solved with our factory tool. The internal SD card of the Suniser 8 is reformatted, the current firmware is installed and then your configuration is reloaded into the fresh system. If there are problems loading and restoring your configuration - please dispense with this point, repeat the process and select "no". After the restart, you can import your personal backup file in the usual way.

Let's go, open this link and follow the instructions/options.

<http://sunriser.ledaquaristik.de/factory.html>

## The SunRiser is not found in the network or the connection breaks down.

Incorrect router settings or incompatible network devices may be a cause.

Possible solutions:

Connect the SunRiser directly to the router without using repeaters or PowerLAN adapters if necessary.

Use the SunRiser Finder to establish a connection: <http://sunriser.ledaquaristik.de/>

Important: Please use the Google Chrome browser. Do not use Microsoft Internet Explorer, as it is incompatible.

Please also check the following points:

1. if a GBit switch is used, it must also accept 10/100Mbit devices.
2. DHCP should be activated in your router.
3. the SunRiser must not be blocked by the router's MAC address filter or firewall.

Turn off the Eco or power saving mode of the router.

5. If necessary, disconnect other network devices as a test.

## FAQ

You can find the most frequently asked questions and help with other problems online at:

<http://srdemo.ledaquaristik.de/faq.html>

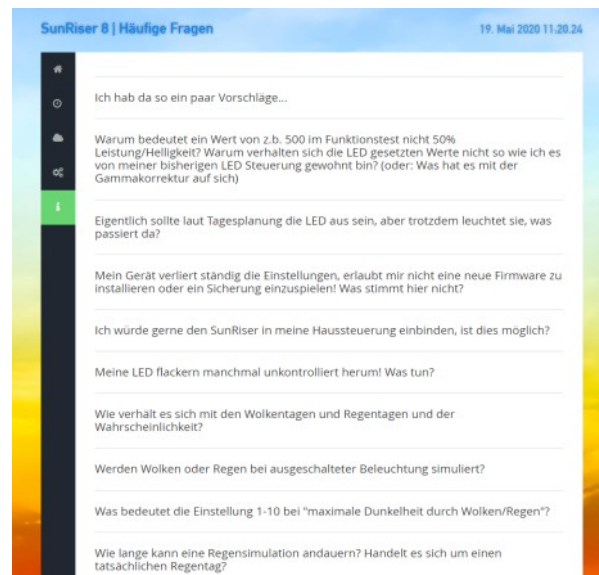

# Temperature sensor for SunRiser 8

For temperature monitoring, the sensor returns the temperature value of water and/or air in °C to the SunRiser 8. The SunRiser 8 can then influence the output channels 1-8 according to the settings made in the web interface. For example, the heat recovery mini pump is switched on or off, the light is dimmed or an email is sent when the water temperature reaches a critical value. In order to be able to monitor different areas, such as air and water or water inlet and outlet, it is also possible to connect 2 sensors by means of a Y-cable.

## Possible functions based on the temperature value

- Switch off channel
- Dim channel down to preset value
- Dim channel up to preset value
- Switch channel on
- Execution only in certain months, e.g. summer
- Alarm e-mail when critical temperature is reached
- Regular status e-mail

## Scope of delivery:

1x waterproof temperature sensor for fresh and seawater in black, incl. 200cm cable and plug

## Connection:

Connection to "1-Wire" or "Sensor" port of the SunRiser 8 (front).

Please disconnect the SunRiser 8 from the power supply before connecting!

A screenshot of the SunRiser 8 web interface for sensor configuration. The page title is 'SunRiser 8 | Sensoren' and the date/time is '11. Dezember 2020 15:08:08'. The interface shows configuration options for two temperature sensors. The first sensor is selected, showing an 'Aktueller Sensor Wert' of 25°C and 'Sensor Aktiv' status as 'AN'. Configuration fields include 'Sensor Name' (set to '#2 Temperatur'), 'Gewünschter Minimum Wert' (22), 'Gewünschter Maximum Wert' (28), 'Emails für Status (kommasepariert):' (info@email.de), 'Alle X Stunden Status Email senden:' (0), 'Sensor nur in diesen Monaten nutzen (sonst alle):' (with checkboxes for months, August is selected), 'Feste Abweichung:' (0), 'LED #1 Wert bei unter Minimum Wert:' (checkbox), 'LED #1 Wert bei über Maximum Wert:' (checkbox with a slider at 0%), 'LED #2 AUS/AN bei unter Minimum Wert:' (checkbox), and 'LED #2 AUS/AN bei über Maximum Wert:' (checkbox). A 'Speichern' button is at the bottom right.

## Y-Cabel

The Y-cable is used for double assignment of a channel of the SunRiser 8, SunRiser 6, SunRiser 2+ or DIMIX 6, taking into account the maximum connected load per channel! (See operating instructions / technical data light control)  
For the SunRiser 8, it can also be used to connect a second temperature sensor to "1-Wire".

### Scope of delivery:

1x 30cm Y-cable (2x socket + plug, 1x open wire)

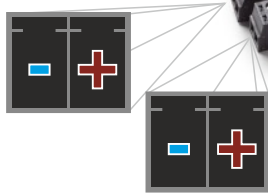

## Flexible wall mount for lighting controls

The 3M Dual Lock Velcro Pads are a very high quality, self-adhesive, Velcro, flexible pressure fastener for easy and re-releasable connecting or fastening. Perfect for attaching our lighting fixtures to the wall or ceiling of the aquarium cabinet. Without drilling! Stick, attach, done! Remove again if necessary!

- Diameter : 48mm
- Quantity : 2 (1 set)
- Colour: black

Important: The surface must be cleaned thoroughly and free of grease before application.



# WLAN extension for SunRiser 8

No network access nearby? Here is the WLAN solution!

Setting up the WLAN extension is child's play: To connect the WLAN adapter to the router, first press the WPS button on the router followed by the WPS button (RE) on the repeater. That's it! Then you can plug the adapter into any socket within the WLAN range without having to make any further settings. The SunRiser 8 is now accessible in your network!

The intelligent signal lights show the current signal strength received by the WLAN adapter. This allows you to easily find the best operating location. For optimal signal strength, it is recommended to place the repeater in a location where 3-4 LEDs are lit.

With the Tether app, you can easily manage your WLAN adapter from any iOS or Android device.

## Features

- WLAN expansion at the touch of a button
- Up to 300 Mbps WLAN speed
- One LAN port for integrating the wired SunRiser 8 with a WLAN
- Miniature design to plug into the wall socket
- Practical signal strength indicator helps with optimal placement
- Compatible with all 802.11b/g/n WLAN routers

## Technical data





- Plug: EU
- Interface: 10/100Mbit/s RJ45 Ethernet port
- Buttons: WPS (RE), reset
- WLAN standards: IEEE802.11n, IEEE802.11g, IEEE802.11b
- Dimensions (W\*D\*H): 110mm\*65,8mm\*75,2mm
- Antennas: 2 internal
- Frequency: 2.4..2.4835GHz
- WLAN security: WEP with 64, 128 and 152 bit, WPA-PSK/WPA2-PSK
- Power consumption: 3W



Questions? Perhaps you will find the answer in our FAQ: <http://faq.ledaquaristik.com>

#### How many LED bars do I need for my freshwater aquarium?

The correct number of LED bars does not only depend on the size of the aquarium. Decisive factors are also the degree of planting, furnishing and, last but not least, personal taste and expectations. Here is a non-binding overview to help you decide on the number of LED bars:

Planting	Light requirements	Quantity eco+	Quantity PRO <sup>2</sup>	Quantity aquaLUMix
None to little		1	1	1
Unpretentious		2	1-2	1
Much, Promising		3-4	2-3	1
extreme(AquaScaping)		4+	3+	1-2

The values refer to average pool heights and depths around 60cm. The arrangement of the strips, whether centrally, offset, split, parallel or side by side, is entirely up to you. Just like the choice of light colours!

Please bear in mind that every aquarium, including yours, is an individual item, so the question of lighting cannot usually be answered in a general way from a distance. We will be pleased to prepare a personal quotation for you. In order to be able to better take your wishes and ideas into account, please follow the link to our website: <http://quotation.ledaquaristik.com>

More questions and answers at <http://faq.ledaquaristik.com>

We will also be happy to help you personally: Mon.-Fri. 8:30-12:00 and 13:00-16:30  
Email: [support@ledaquaristik.de](mailto:support@ledaquaristik.de) | Live-Chat on [www.ledaquaristik.de](http://www.ledaquaristik.de) | Phone: 05257/9366650

## High-Power-Solution for SunRiser

With the High-Power-Solution, a specially configured and dimmable LED power supply unit is used on an output channel of the SunRiser lighting control system. This so-called master/slave operation enables a connected load of up to 192W (-10%) per channel on a SunRiser!

### Functional description:

In the standard application, a SunRiser draws power from an LED switching power supply and sends it to the LEDs via its output channels. Thus, the maximum possible number of LED bars to be connected is limited by the maximum power of the power supply unit, or by the maximum connected load of the control unit and the individual channel. In the example of the SunRiser 8, this means a maximum of 240W/12V. For extensive projects, the limit of feasibility is quickly reached and a second or third system must be used.

**High-Power-Solution:** The master/slave solution described below offers a considerable increase in performance. One of our "standard" LED switching power supplies of any power serves as the master. The 35W model is already sufficient, and only supplies power to the lighting control system itself. As slaves, specially configured LED power supplies are connected to the output(s) of the lighting control system. These are available with a connected load of either 120W or 192W (minus 10% reserve). A single SunRiser 8 can thus control a maximum of 8x 192W/12V (-10%), which would correspond, for example, to approx. 48 eco+ LED bars of 100cm each. Even 8x aquaLUMix 144cm on one SunRiser 8 can be realised in this way.

In addition, the slave power supply units can be set up decentrally for lighting control. This means that only the control cable needs to be extended and the cables of the LEDs can be kept short. This neither impairs the efficiency of the LEDs nor increases their susceptibility to interference due to extreme cable lengths. To connect several LED bars to one power supply unit, you will find the LED splitter in our shop. Of course, all LEDs connected to a slave power supply unit are dimmed/controlled together.

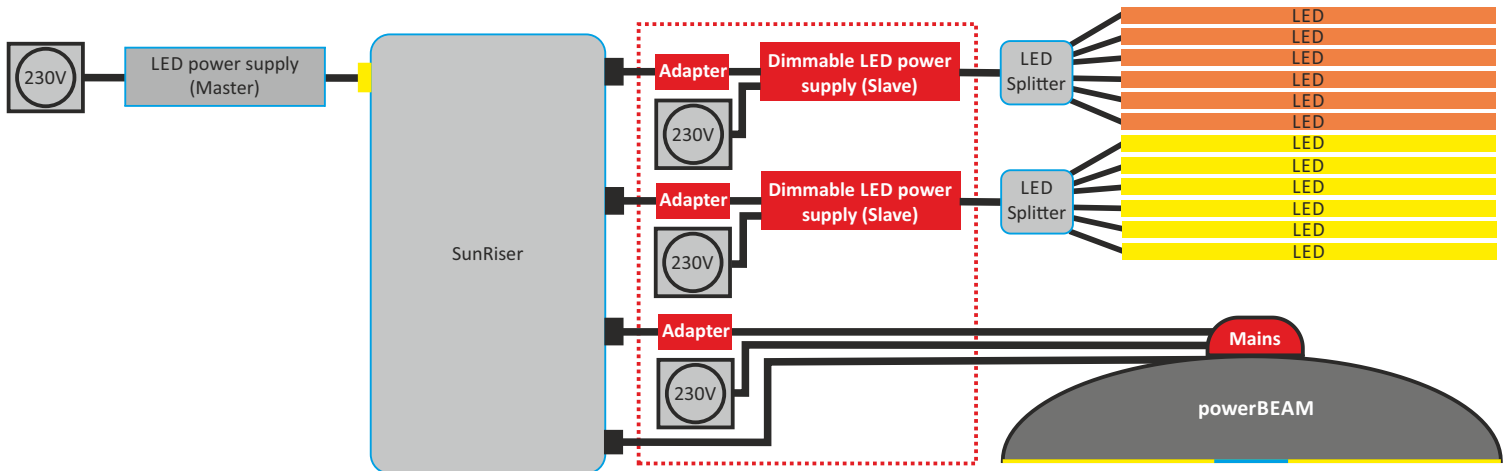

## High-Power-Solution

### Please note:

The power supply unit may only be used with the supplied adapter plug on the SunRiser 4+, SunRiser 6, SunRiser 8 or DIMIX6.

The power supply units should be operated with LEDs that require at least 60% of the max. connected load.

The dimming function of the power supply units cannot technically implement the 1-10% dimming range. A very weak glow of the LEDs, as allowed by the SunRiser in normal operation, is not possible here. For this minimum range, an LED bar connected directly to the lighting control system should be used.

**Compatible with:** SunRiser 4+, SunRiser 6, SunRiser 8, DIMIX 6

**Scope of delivery:** 1x power supply unit including connection adapter to an output/channel of the products listed above.



## The switch-on point

### Using the High Power Solution or powerBEAM with the SunRiser 4+, 6 and 8

The lower or fine dimming range between 1-10% is technically not possible with the High-Power-Solution or the main channel of the powerBEAM. However, to ensure that the light switches on at 1% according to the programming and not only with a time delay from an undefined range >10%, the SunRiser 6 and 8 controllers offer the option of setting the "switch-on point" individually in their settings. The switch-on point is used to determine the lowest possible PWM value at which the connected LED (powerBEAM / High-Power-Solution) switches on. This value is then saved and from now on processed as the lowest (1%) setting when the light is switched on. If several channels are used with powerBEAM or High-Power-Solution, the switch-on value must be set individually in each case.

## powerBEAM - The dimmable LED pendant luminaire for large installations.

The powerBEAM LED luminaires are ideal for open or transparently covered aquariums/terrariums with a high light requirement. With a system power of 125W or 240W, the special features of these luminaires are the light colours that are specially matched to their intended use. You can choose between AMAZON-GROW for demanding planting, AFRICAN-SUN for moderately to non-planted habitats and SEAWATER for marine aquariums are available. In addition, the powerBEAM LED luminaires are dual-channel dimmable and therefore very suitable for day simulation and light control. The main light with 100W or 200W power can be used for sunrise and sunset simulation and provides outstanding brightness and colour rendering during the day. In the evening and at night, the separately dimmable moonlight (inner LED circle) with a maximum of 25W or 40W power provides a very special blue effect.

The powerBEAM is a pendant luminaire and is mounted on the ceiling with a wire suspension. The optional reflector restricts the beam angle of the luminaire from 110° to 90° if required, also deflects stray light downwards and serves as an anti-glare shield at the same time. The die-cast aluminium heat sink has excellent thermal conductivity, so the powerBEAM does not require active fans for cooling and is therefore absolutely silent.

### Dimmability

- Main light, via enclosed adapter to DIMIX6, SunRiser 6 and SunRiser 8, dimming range 10-100%, <10%=off. See "Switch-on point" on page 96. Not compatible with SunRiser 2.
- Moonlight, directly via a dimmer or light control from our range and separate 12VDC power supply unit, dimming range 0-100%.







AFRICAN-SUN



AMAZON-GROW



SEAWATER

Full spectrum  
LED

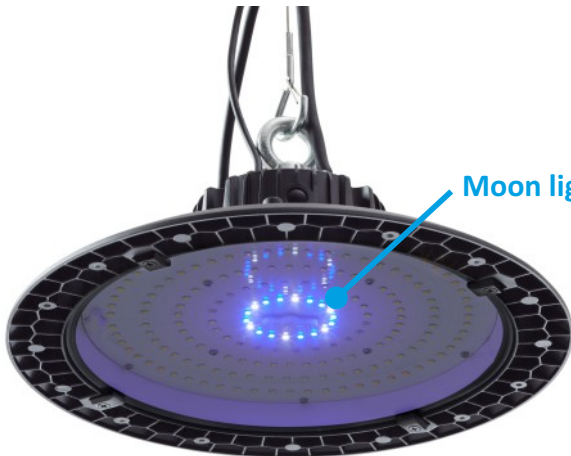

Moon light



90° Reflector

## powerBEAM - Connection



- Main light with its own integrated and dimmable MeanWell power supply. Control cable 250cm open wire, as well as 250cm cable for mains connection to 230V with Schuko plug, connection according to the principle of the SunRiser-High-Power-Solution (see page 83).
- (Power supply unit and adapter are already included with the powerBEAM!)
- **Attention:** The main light may only be used with the supplied adapter plug on the SunRiser or DIMIX6.
- Moonlight with 250cm connection cable to 12VDC, power supply is thus via the switching power supply unit of the light control.
- **Use with SunRiser 4+, 6 and 8, see page 94.**

# powerBEAM - Details

## Scope of delivery

- powerBEAM light
- Steel cable 150cm for suspension with safety carabiner and height-adjustable ceiling fixture
- Adapter for connecting the main light to a lighting control system, see connection plan

## Features

- Colour rendering index: up to 86 Ra (CRI)
- Voltage: main light 230V, moonlight 12V DC (direct voltage)
- LED chip life: ~50,000 hrs.
- Light source can be replaced by qualified personnel
- Ambient temperatures: -30°C to +50°C, 10% to 90% RH.
- Switching cycles until premature failure: approx. 100,000
- Connections to further accessories according to the scope of order
- Protection class: IP65 not suitable for underwater use!

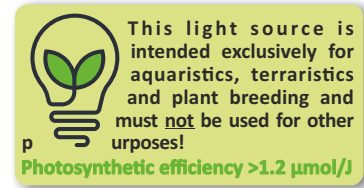
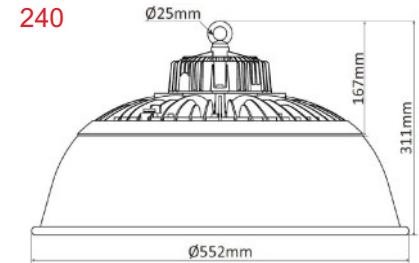
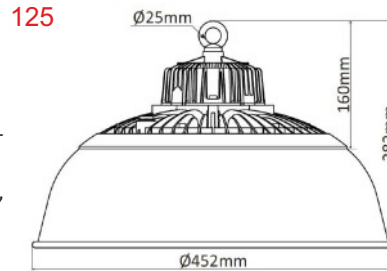

## Technical data based on the AMAZON-GROW

Version	Hauptlicht					Moon light			
	LEDs total	Lumen	Output/consumption	Efficiency	PAR at 30cm	LEDs total	Lumen	Output/consumption	Efficiency
125	165 pcs	17.321 lm	102 W = 102 kWh/1000h	170 lm/W	670 µmol/m <sup>2</sup> s	20 pcs	701 lm	24 W = 24 kWh/1000h	30 lm/W
240	322 pcs	33.330 lm	203 W = 203 kWh/1000h	165 lm/W	1184 µmol/m <sup>2</sup> s	40 pcs	1.307 lm	41 W = 41 kWh/1000h	32 lm/W

## Light composition

Version	Main light											Moon light			
	Ø	RED 730nm	RED 660nm	GROW	3500K	4500K	5500K	6500K	11000K	13000K	UV 380nm	UV 410nm	BLUE 450nm	13000K	BLUE 450nm
AMAZON-GROW	5500K	2%	8%	15%	15%	15%	10%	35%	/	/	/	/	/	20%	80%
AFRICAN-SUN	7500 K	2%	8%	/	/	/	15%	30%	30%	15%	/	/	/	20%	80%
SEAWATER	>20.000K	/	2%	/	/	/	/	/	/	44%	5%	5%	44%	10%	90%

## easyBEAM LED spot with E27

With easyBEAM, experience an incredible depth effect in your aquarium that brings your underwater landscape to life. Our high-quality CREE LEDs provide precise illumination, showcasing your fish and plants in the best light.

Our simple concept offers a user-friendly installation thanks to the standard E27 bulb socket. Whether you are an experienced aquarist or just starting out, easyBEAM adapts to your needs.

By combining innovative technology with intelligent design, easyBEAM provides an optimal light source for any type of aquarium. Create stunning visual effects in your aquarium while your underwater world shines in a new light.

Experience the revolutionary aquarium lighting of easyBEAM now and

Equipped with 12 ultra-bright CREE LEDs. Choose from 3 different light colors:

**PlantMix** - The PlantMix light colour consists of a combination of 6x 6500K XPE, 4x 5000K XPE, 1x RED XTE, 1x BLUE XTE LEDs. Ideally suited for planted freshwater aquariums or any terrarium.

**DayLight** - The light colour DayLight produces a pleasant clear white light with 12x 6500K XPE LEDs, neutral like daylight.

**DeepBlue** - with Bridgelux LEDs. The DeepBlue light colour provides a deep blue light with 8x BLUE, 3x 12000K, 1x RED LEDs, whereby the 12000K LEDs still provide a proportionate basic brightness, e.g. for saltwater aquariums or to achieve a special depth effect.



PlantMix



Daylight



DeepBlue

## Technical data easyBEAM (based on the PlantMix light colour)

- Dimensions: d=122mm, h=127mm
- Equipped with: 12x CREE LEDs
- Luminous flux 2830 lm
- Efficiency approx. 146 lm/W
- Dimmable: NO
- Base: E27
- Beam angle: 90
- Power: ~18 W
- Weighted energy consumption: 18 kWh/1000h
- Voltage: 230V
- Lifetime: > 50,000 hours
- Light source can be replaced by qualified personnel
- Switching cycles until premature failure: approx. 100,000
- Switch-on time: <0.5s

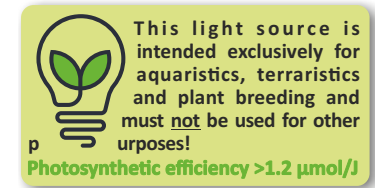
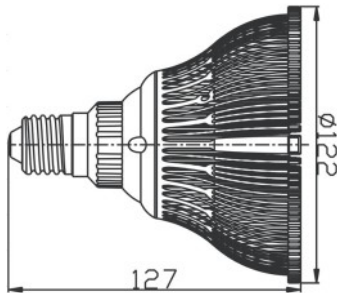

An easyBEAM cools itself independently via the ambient air. Make sure that the lamp can dissipate the heat generated unhindered. If the lamp is used in a housing that is too narrow or too closed, there is a risk of premature failure due to excessive operating temperature.

# flexBEAM

The flexBEAM LED Spotlight is synonymous with versatility and adaptability. It provides you with a tailor-made solution, whether as a replacement for traditional HQL lights or as a pendant light with an elegant steel cable suspension. With its high-quality components, it is perfectly suitable for various environments.

## 1. Power and Light Colors: The Right Light for Every Need

- Choose between two power options: approx. 40W or 75W.
- Diverse light colors enable usage in different scenarios:
  - \* For Plant Lovers: PLANT-MIX and AMAZON-GROW.
  - \* For Cichlid and Community Aquariums: DAY and AFRICAN-SUN.
  - \* For Marine Enthusiasts: SEAWATER

## 2. Beam Angle and Lens: Control Your Light

- Solidly constructed and easily replaceable glass lenses offer choices between 60° or 90° beam angles.
- For more flexibility, a polycarbonate cover is also available, allowing for a 120° beam angle.
- Please note that illumination varies depending on the height of the spotlight above the ground.

## 3. Optional Accessories: Perfect Your Lighting

- Pendant Light with E27 Socket: Our inconspicuous metal mounting set allows for a stylish installation above the aquarium (incl. E27 lamp socket, sturdy and shorten-able braided fabric cable, ceiling mount for 230V direct connection).
- Reflector: Minimize scattering losses and direct the light exactly where it's needed. Our reflector shade is optionally available depending on your needs.

The flexBEAM LED Spotlight stands for quality, flexibility, and innovative technology. With its wide range of options and accessories, it's more than just a light – it's your custom configurable lighting system. Explore the possibilities and take your lighting to the next level!

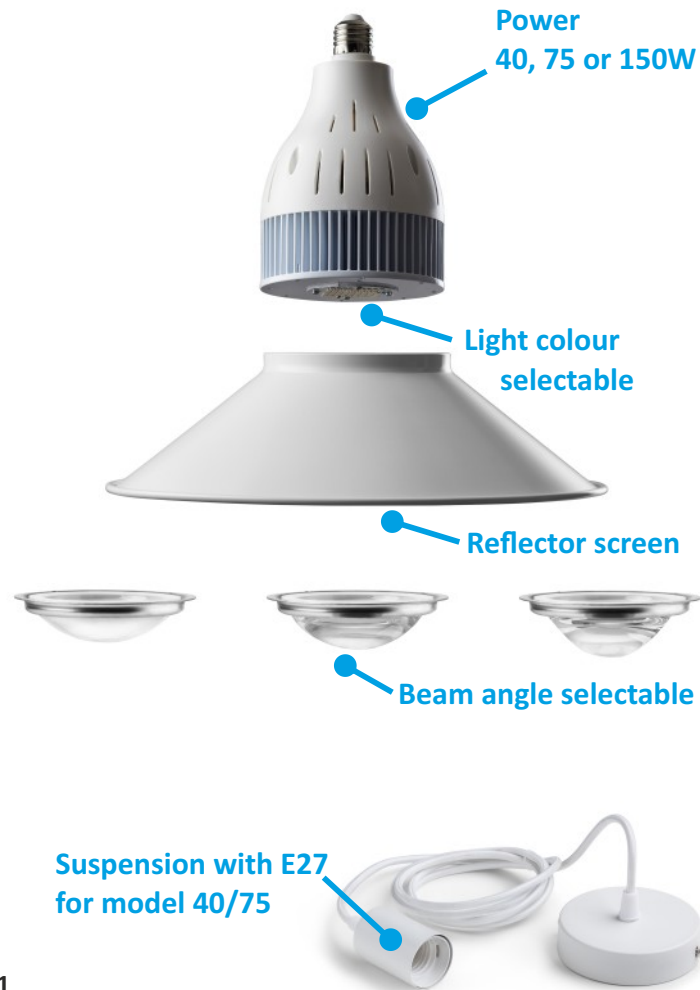

flexBEAM



*AMAZON-GROW*



*PLANT MIX*



*AFRICAN-SUN*



*SEAWATER*



# flexBEAM Koi

## The ideal lighting for indoor Koi keeping.

The flexBEAM "Koi-Edition" features a unique COB-LED. Not only does it **maintain the colors** of your Koi, but it also **restores the vibrant colors to faded animals**. For successful keeping without natural sunlight. Configure your flexBEAM LED spotlight as needed with a 40W, 75W, or 150W LED chip.

*The difference between the flexBEAM "Koi Edition" with COB LED and our standard flexBEAM with SMD LED primarily lies in the LED technology used. COB LEDs are more efficient and powerful, offering better heat dissipation and light quality. These characteristics make them particularly suitable for specific applications such as lighting indoor Koi ponds.*

*However, COB LEDs are more complex to manufacture and, as a custom-made product, more expensive to procure compared to SMD LEDs, which are composed of many small individual LEDs. The additional investment in the "Koi Edition" variant with COB technology is justified by the unique light quality for this particular application. The COB chip of the flexBEAM "Koi Edition" was specially developed for its purpose in indoor Koi keeping, aiming to maintain and enhance color. Independent long-term tests by well-known importers, dealers, and private customers from the Koi community uniformly rate this spotlight as "very good". In contrast, the SMD version of the flexBEAM was primarily designed as pure aquarium LED lighting. The main focus of the SMD variant is on the planting or the natural lighting of the respective habitat. There is no experience regarding its use with Koi.*



Configure and order:



[www.ledaquaristik.de/koi/en](http://www.ledaquaristik.de/koi/en)



flexBEAM



*With reflector*



*Beam angle:*



$60^\circ$



$90^\circ$



$20^\circ$



# Technical data flexBEAM LED spotlight

- Weight approx. 840g (40/75W), 1450g (150W)
- Diameter reflector 33cm (40/75W), 41cm (150W)
- Dimmable: **NO**
- Base: E27 (40/75W), E40 (150W)
- Beam angle: 60°, 90° or 120° (not for 150W) by changeable lens
- Light colour according to choice
- Luminous flux up to approx. 12.000 lm (75W model)
- Power according to selection
- LED efficiency: approx. 185 lm/W (75W model)
- PAR/PPFD at 30cm: 675  $\mu\text{mol}/\text{m}^2\text{s}$  (75W model)
- Efficiency of power supply unit: approx. 93%
- Weighted energy consumption: 41, 76 or 152 kWh/1000h
- Voltage: 230V
- Service life: > 50,000 hours
- Light source can be replaced by qualified personnel
- Switching cycles until premature failure: approx. 100,000
- Switch-on time: 0.5s
- Operating noise of fan: 14.5 dBA

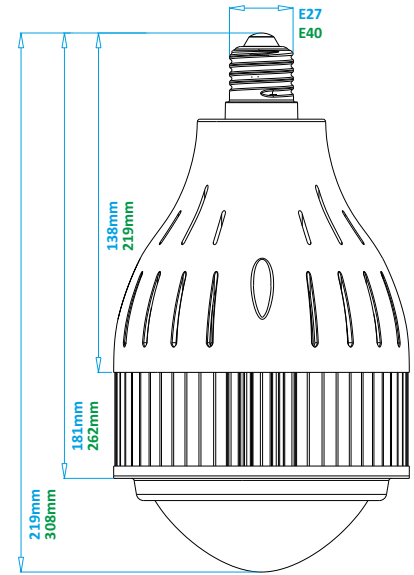
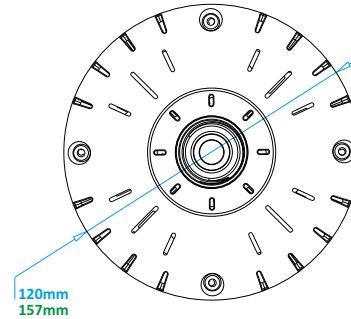

Variante 40 and 75  
Variante 150

Further data and diagrams on the light spectrum are available in the product description under ("Data sheet & key figures") of the respective variant.

*\*The light measurement of the product was carried out according to the scope of delivery in a dry environment at 100% output. The use of focusing lenses, protective covers or reflectors may lead to deviating results. In addition, slight deviations from the test sample may occur due to the batch. PPFD - Photosynthetic Photon Flux Density. PAR - Photosynthetically active radiation. PPE - Photosynthetic photon flux per watt of electrical energy.*

## FURTHER DESCRIPTION

The spotlights have an active-passive cooling system: the patented aluminium heat sink provides the necessary heat dissipation passively, while a quiet magnetic fan cools actively. The fan as well as the integrated and highly efficient power supply unit can be easily replaced if necessary.

A radiator that is housed too tightly will lead to insufficient cooling and overheating, resulting in a shortened service life. A very dusty environment can also lead to a shortened service life.



This light source is intended exclusively for aquaristics, terraristics and plant breeding and **must not** be used for other purposes!

Photosynthetic efficiency >1.2  $\mu\text{mol}/\text{J}$

## References & Partner



**Zoologisches Institut  
der Universität Basel**  
[www.salzburgerlab.org](http://www.salzburgerlab.org)



### Tipp:

In the AQUAHAUS-GAUS, all 21 show tanks from 160 to 300cm in length are illuminated with our LED systems. Almost our entire product range can be seen, from eco+, PRO<sup>2</sup>, aquaLUMix and FlexBeam LEDs to free-hanging lamp housings and the deLUX aquarium cover. So it's well worth a visit to what is probably the world's largest cichlid breeding facility!

**Fisch und Fitz  
Aquariendesign**  
Isarmosweg 49  
DE-84130 Dingolfing

**Der Aquarienbauer**  
Andre Geschwill  
Hans Böckler Str. 39a  
DE-67454 Haßloch

**isabi.de**  
Melanchthonstr. 10a  
DE-14612 Falkensee

**Aqua-Treff**  
Camesallee 15  
DE-40670 Meerbusch

**WEBLU Aquarienbau**  
Weserstraße. 98  
DE-32547 Bad Oeynhausen

# Services

## Order check

You are unsure whether the selected products are compatible with each other or whether something important has been forgotten?

We will be happy to take a close look at your order before dispatch and check whether all the items required for operation are present. Should something be inconsistent we will contact you!

0,00 €

## Programming

Do you want the lighting control system to be ready to go straight away? And exactly according to your ideas? Then the "Programming service" is just the thing for you!

Depending on the selection and device in your order, we program the lighting control system with a

- **Daytime planning** (Mon-Sun same sequence plus time and brightness) or
- **weekly planning** (possibility of creating different sequences Mon-Sun, e.g. a later switch-off time at the weekend).

You can either send us detailed specifications for your desired programming, or we will programme the device according to our experience and your other orders with what we consider to be the optimum lighting programme.

Ab 4,99 €

## Pre-assembly

This ensures the quickest possible start with your new lighting!

Depending on the service selection, our scope of services includes, if your order includes these items:

- Installation of the LED bar(s) in the lamp housing or adapter profile
- Installation of cable extensions, the ordered quantity and length will be distributed evenly to all LED bars of the order scope.
- Installation of screw terminals for connecting the LED lighting to dimmers and lighting controls such as SunRiser 2, 6, 8 or DIMIX6
- Connecting the LED bars to the LED splitter and power supply unit
- Mounting CleanCover on the LED bars

Ab 9,99 €



107



## LED sample case

### Decision support - home loan

Our range is very large indeed! This allows our customers to have a very individual as well as perfect lighting.

The selection, online via the website, can therefore understandably also appear difficult to you.

So why not take advantage of our service and test LEDs, light colours, fixtures, controls, etc. in the comfort of your own home to make the best purchase decision for you!

#### Availability

Only within Germany!

The number of our sample cases is limited. If the desired case is not currently available, please be patient. We will be happy to inform you immediately by email when the case is available again. To do so, please use the "Notify me when available" function, which you will find in the respective product description directly above the price information.

#### Prices and rules

Price: 14,99 € (packing, shipping & return by DHL)

Deposit: 250,00 € (will be refunded after return!)

Loan period: maximum 7 days. (On the 7th day after receipt, the case must be returned to a DHL branch with the enclosed return label. If the period is exceeded, €10.00 will be charged for each day exceeded and retained from the deposit amount!)

We send you high quality goods and expect you to handle them accordingly. Missing or damaged samples will be charged.

Thank you for your understanding and have fun trying them out!



aquaNUMix



eco+ / PRO²

For price information  
please visit our shops:

[www.ledaquaristik.de](http://www.ledaquaristik.de)  
[www.ledterrariumistik.de](http://www.ledterrariumistik.de)



Shipping costs to  
EU countries from 15,95€

We would be pleased  
to prepare a Personal offer  
<http://quotation.ledaquaristik.com>



**% Shop discount %**  
**3% from € 333**  
**5% from € 555**

Special discount promotions may invalidate the above regulation.

All prices incl. 19% VAT plus shipping.

\*Subject to change - prices of the WebShop are valid.

109 The statutory rights of liability for defects according to German law apply.

## Customer opinions

**Tobias H.:** Hi, I installed the lamps this evening. A really easy process, push the LEDs in, clamp, plug-in and WOW! As different as night and day - as they say... In next to no time, my plants had tiny bubbles - something I have not seen since my old 360 tank with HG lamps. \*Happy\* I'm really pleased that I didn't buy new fluorescent tubes but treated myself to two 47cm PRO's and a 20cm GROWx5 instead. I can't wait to see how things go with the tank temperature: I've already turned down the heater. True - the tank cools down at night because the LEDs are on only during the day; but in nature there is also no heat at night. ^^

**Thomas W.:** I've had the GROWx5 working for a good week now! Awesome! I had no idea how extraordinarily beautiful the light would be. And the plants are assimilating like mad! I have an 80cm bar in use with an eco+ DAY I already had... I intend to put something together for my Juwel Vio 40 now... I'm amazed!

**Gert G.:** I would just like to express my thanks for the expert advice! My tank looks a winner and I am very satisfied with the lighting system: Good quality, easy to install and I've even mastered programming the SunRiser :-)

**J. Honring.:** Dear Team, I ordered the standard kit for my Juwel Vision 450 a long time ago - I'd say April 2016 - and now, because everything was manufactured carefully by hand, the tank is finally complete. Installing the lights was really easy - even for me - and I can definitely recommend their lighting effect. Thank you!

**Matthias H.:** Thanks very much for the super LEDs. Very quick delivery and top-class service! I had wanted to switch to LED for some time, but it was much too expensive for me until I hit on your website :) where I found top-quality at super prices! The difference in the colour of the fish compared with before is truly amazing!! I have 2x 50cm SUNSET and 2x 80cm SKY bars controlled with SIMU-LUX! It's awesome!!

**A. Flemmer.:** I just wanted to say a sincere thank you for your good advice and great products. I set up a 1400 litre tank with dimensions 200x100x70 ... This tank is illuminated by 3 eco+ DAY bars, 80cm in length placed transversely... The result is spectacular... So bright that I have to dim them... Incredible! 1400 litres and lit with 3 eco bars - I would never have thought it possible... Thank you for everything, until the next time...

**Christian A.:** I run a 100x40x50 aquarium with one 80cm SKY LED and even that is dimmed to 75%. Because the tank was planted only with Cryptocorine, Anubias and mosses, the new lighting intensity needed to be rather low. But even with these plants, you can design a fantastic aquarium. My experiment to design a weakly lit aquarium has finally come to an end and, most notably, there is absolutely no algae growth. These LED bars work like a dream.

More customers' opinions with extensive descriptions and customer photographs can be found <http://customer-reviews.ledaquaristik.com>

PRO<sup>2</sup> POLAR + MARINE



More customer photographs, descriptions and customers' opinions <http://customer-reviews.ledaquaristik.com>

spotBEAM PLANT-MIX



aquaLUMix AMAZON-GROW





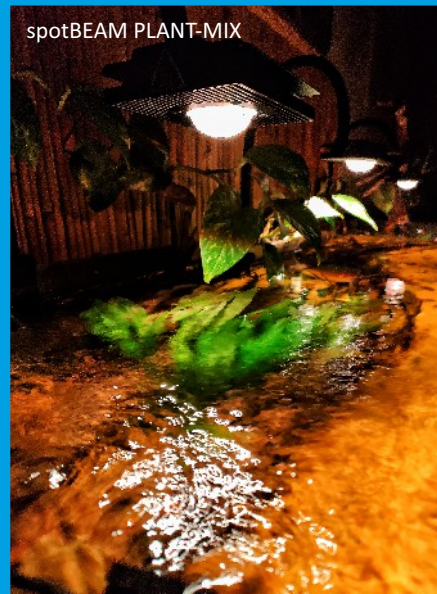
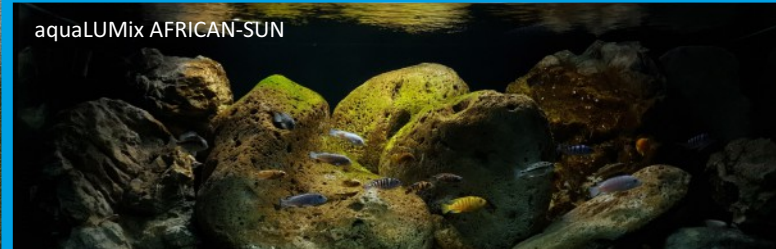



Show tank Malawi Predator Bay 2020  
2200 litres 302x86x84cm with deLUX cover titanium grey  
aquaLUMix AFRICAN-SUN 74cm & 34 cm per SunRiser 8  
Further information under:  
<https://www.einrichtungsbeispiele.de/42963.html>





Have fun with your  
new lighting,  
from LEDaquaristik

## LEDaquaristik GmbH Support - Contact

+49 (0) 171 807 84 81  
Fon: +49 (0) 5257 93 666 50  
Fax: +49 (0) 5257 93 666 51

Email: [support@ledaquaristik.de](mailto:support@ledaquaristik.de)  
Live Chat: [www.ledaquaristik.de](http://www.ledaquaristik.de)  
[www.facebook.com/LEDaquaristik.de](http://www.facebook.com/LEDaquaristik.de)

Schierbusch 2 | 33161 Hövelhof | Germany

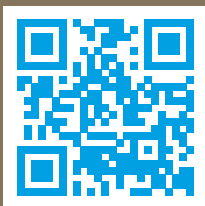

LEDaquaristik GmbH  
Schierbusch 2 - 33161 Hövelhof - Germany  
WEEE-Reg.-Nr.: DE25420047 - BattG DE74524241  
Registro Produttori AEE n° IT17090000010023  
Registro Produttori Pile e Accumulatori n° IT17090P00004580



All prices incl. VAT! While stocks last! Errors and omissions excepted. Illustrations may differ from the original.